



Storage systems



Contents

Storage systems

PALLET STORAGE SYSTEMS

- 06 Conventional pallet racking**
The universal system for direct access to each pallet.
- 08 Movirack mobile pallet racking**
Large-scale storage on mobile shelving units.
- 10 Drive-in pallet racking**
Storage by accumulation with optimal use of available space.
- 12 Semi-automatic Pallet Shuttle**
Optimised accumulative storage system.
- 14 Live pallet racking**
Ideal for storing high turnover perishable goods and high consumption products.
- 16 Push-back pallet racking**
Ideal for storing medium turnover goods, with two or more pallets per SKU.
- 18 Clad-rack warehouses**
Great works of engineering in which the racking forms the structure of the building.
- 20 Automated warehouses for pallets**
Automation for maximum efficiency.
- 22 Stacker cranes for pallets**
Machines created for the automated storage of loads.
- 24 Automatic Pallet Shuttle**
The most efficient solution for mass product throughput.
- 26 Automatic trilateral stacker cranes**
The perfect solution to automate conventional racks.
- 28 Conveyor systems for pallets**
Set of elements designed for transporting, accumulating and distributing pallets.

BOX STORAGE SYSTEMS

- 30 M7 Longspan shelving**
Shelving with multiple possibilities for picking of bulky or heavy loads.
- 32 Racks for picking with gangways**
Maximise the use of warehouse's height.
- 34 M3 shelving**
Manual storage and archiving system for light and medium loads.
- 36 Live storage for picking**
Perfect turnover is within arm's reach.
- 38 Automated warehouses for boxes**
Optimum for storage and picking operations using the "product-to-person" concept.
- 40 Stacker cranes for boxes**
Using robotics to reach high levels of productivity and automate load management.
- 42 Conveyor systems for boxes**
Transport devices to cover any distance within an installation.

OTHER SYSTEMS

- 44 Cantilever racking for long loads**
A simple system designed for the storage of long loads.
- 46 Mezzanine floors**
Industrial raised flooring used to multiply the original surface area.
- 48 Mesh Partitioning**
Useful to enclose different work areas.
- 50 Custom projects**
Our customised storage service.

MANAGEMENT SOFTWARE

- 52 Easy WMS Warehouse Management System**
Control, coordinate and manage all the processes at work in a warehouse.

SERVICES

- 54 Technical inspections of racks**
Rack use, inspection and maintenance.

Quality standards



ISO 9001

Mecalux is certified with the ISO 9001, the quality control management system for the design, production, installation and after-sales service of its storage products. The ISO 9001 certificate has been awarded to the production plants in Spain, Mexico and Argentina for all our metal racking for static, mobile and live storage, light-duty shelving, mezzanines, lockers and office partitioning.



ISO 14001

Mecalux is aware of environmental issues and the environmental repercussions of the work done at its plants. Applying the Environmental Management System (EMS) to our activities guarantees that all our organisational, production and technical work which could have an effect on the environment is planned, managed and controlled to comply with the established requirements in the ISO 14001 standard.



ISO 45001

Occupational risk prevention is currently a very important factor in the daily management of every company. With the aim of preventing accidents and ensuring a safe working environment, Mecalux has obtained the internationally recognised ISO 45001 certification which specifies the requirements for the proper health and safety management in the workplace.

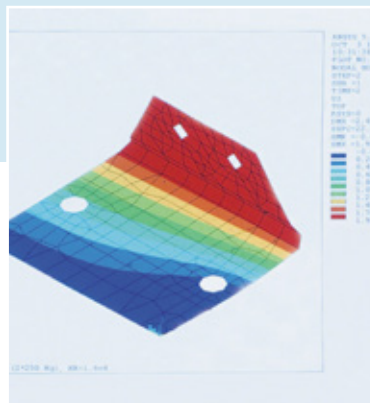

TÜV-GS

In October 2000, the world renowned German company, TÜV Product Service GmbH, awarded Mecalux its quality certificate after auditing and testing the material handling instructions and the design, production and assembly processes of our products.

EN 15512 STANDARD

Conscious of the need to apply the most advanced safety techniques to racking and shelving, Mecalux has been adapting its products and services to suit the European Federation of Materials Handling's recommendations for the new system of calculation, design and testing of metal shelving since 1995.

These recommendations form European standard EN 15512, which is in line with the existing EU directive on the calculation of metal structures for conventional shelving. This also regulates the process and the tolerances in the assembly and control of materials. Its objective is focused on global analysis of the stability and resistance of the shelving applying second order calculation methods using finite elements.

Conventional pallet racking

- ✓ The universal system for **direct access** to each pallet.
- ✓ **Makes maximum** use of storage locations.
- ✓ Can be **adapted** to any size or weight of pallet.



Conventional pallet racking is the best solution for warehouses where it is necessary to store a wide range of articles on pallets.

The variety of profiles and accessories provides optimal adaptation to each load and height requirement.

The layout and height of the racking are determined by the characteristics of the forklifts, the pallets to be stored and the dimensions of the premises.

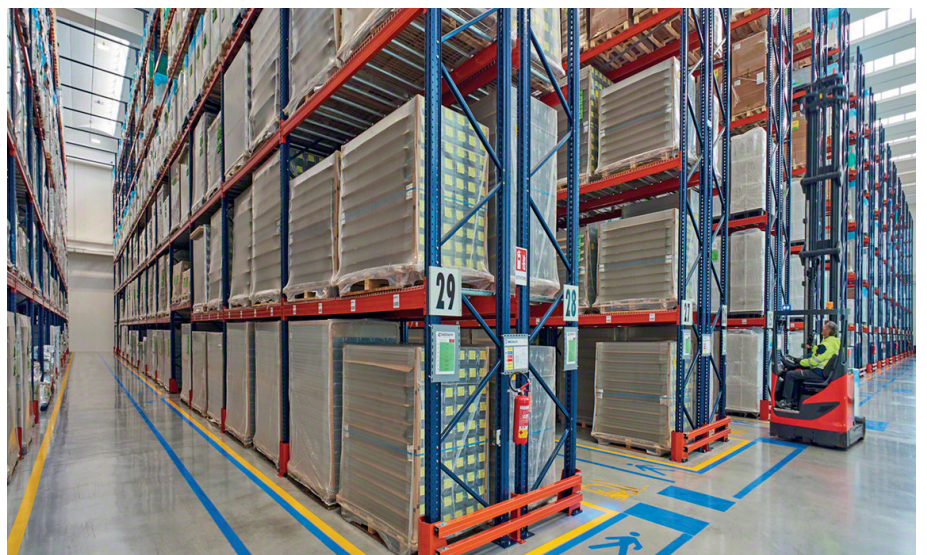

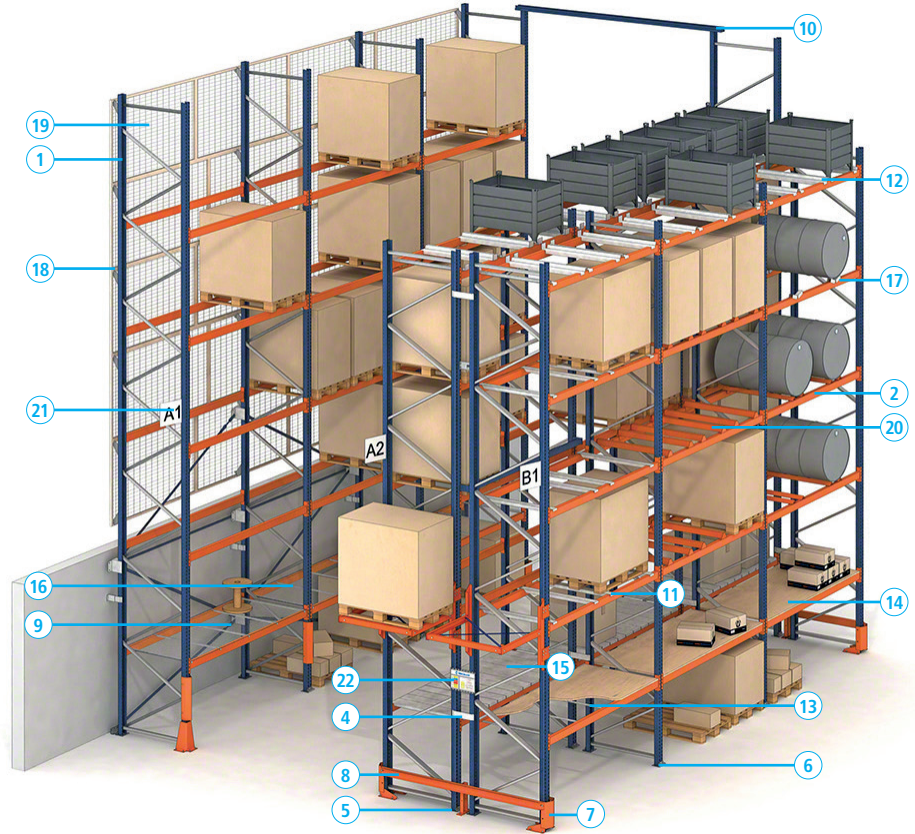

1. Frame
2. Beam
3. Safety locking mechanism
4. Frame union
5. Anchor bolts
6. Levelling shims
7. Upright protector
8. Lateral protection barrier
9. Cross bracing set

10. Top portal tie
11. Pallet cross tie
12. Container support
13. Chipboard shelving cross tie
14. Chipboard or melamine shelf
15. Galvanised picking shelf
16. Mesh shelf
17. Drum support
18. Pallet stop set
19. Anti-fall mesh
20. Raised cross tie
21. Aisle identification plate
22. Signalling plate



Combine with longspan shelving

Conventional pallet racking can incorporate longspan beams for the manual selection of goods as orders are often prepared in the access aisles.

Movirack mobile pallet racking

- ✓ **Optimisation of space** and **increased** warehouse storage capacity.
- ✓ **Direct access** to each pallet.
- ✓ Optimal system for both **refrigerated** and **frozen cold storage**.



The racking is mounted on mobile bases which move along rails, eliminating the need for multiple access aisles and increasing storage capacity.

Mobile pallet racking makes maximum use of available space and provides direct access to each of the pallets stored within the system.

The mobile bases have motors, sliders, electronics and several safety systems to guarantee safe, efficient operation.



Racks

1. Frame
2. Beam and safety pin
3. Anchorage and fasteners
4. Vertical bracing
5. Horizontal bracing
6. Base fasteners
7. Console (optional)

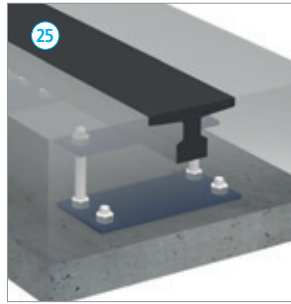

Roller rail

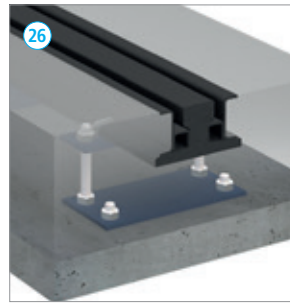

Guide rail

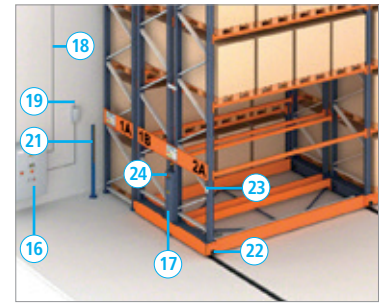

Mobile bases

8. Roller carriage / drive carriage
9. Guide carriage
10. End of carriage
11. Base beam
12. Bracing set
13. Motor
14. Cable channel
15. Drive shaft

Safety and control parts

16. Main power cabinet
17. Onboard power panel
18. Signal and power cables
19. Remote control antenna
20. Remote control
21. Exterior safety barrier
22. Interior safety barrier and proximity photocell
23. Reset button
24. Emergency stop button

Built-in tracks

25. Roller rail
26. Guide rail

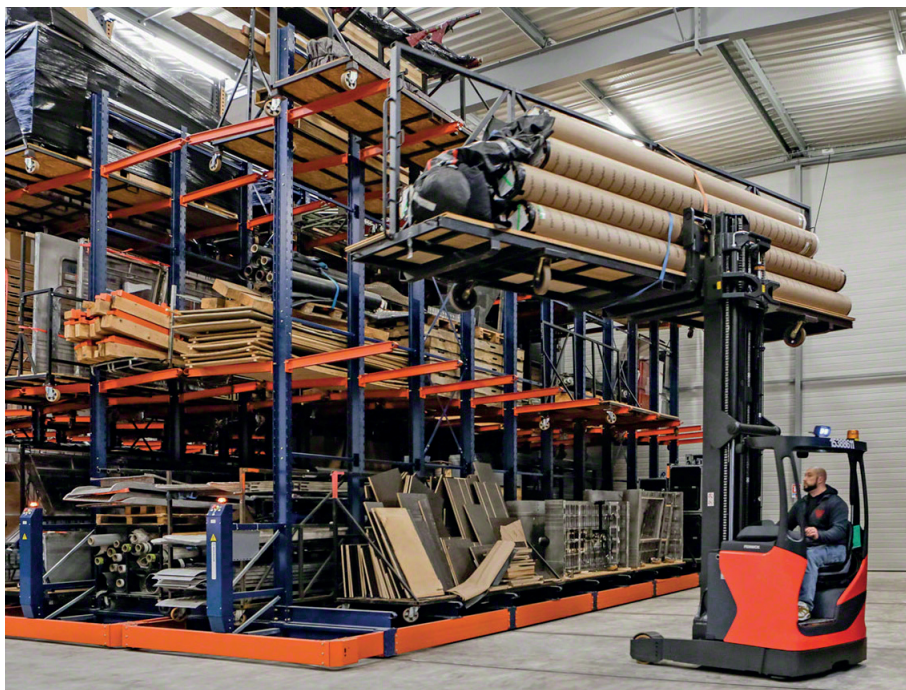
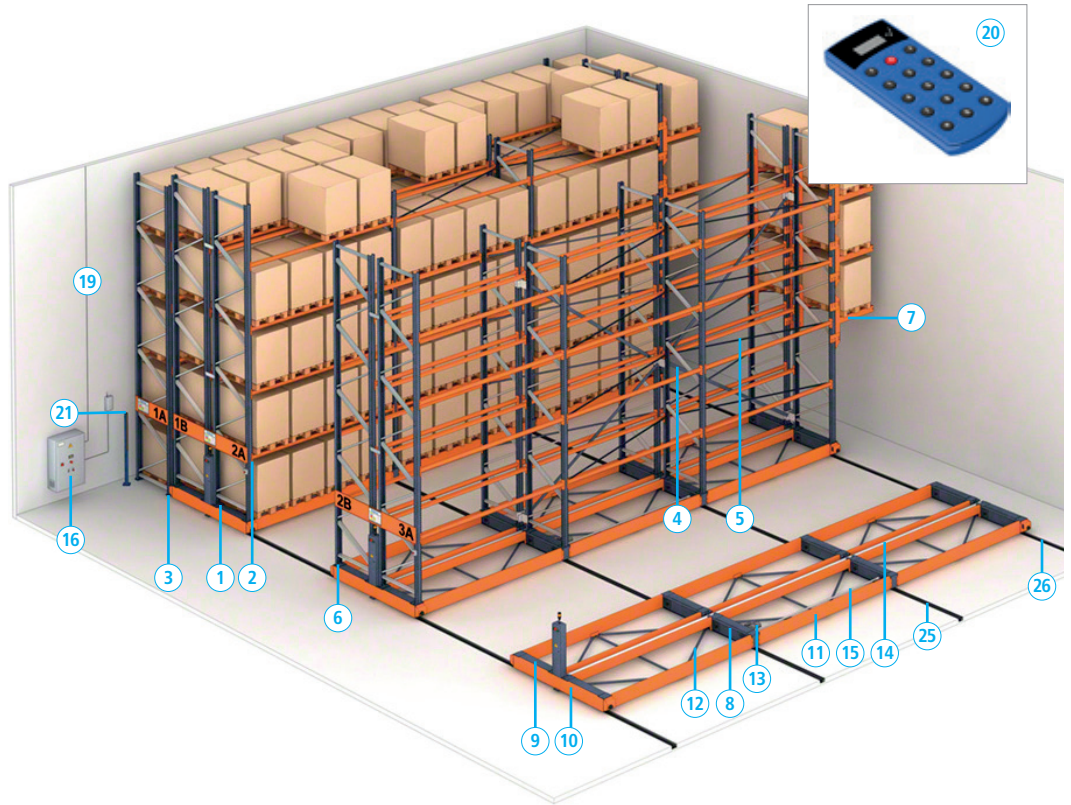

Combined with cantilever racks

Mobile pallet racking can incorporate cantilever shelves when it is necessary to store longer products and increase warehouse storage capacity.

Drive-in pallet racking

- ✓ **Maximum profitability of the available space** (up to 85%).
- ✓ Ideal system for **storing homogeneous**, low turnover products with a large number of pallets per SKU.
- ✓ **Aisles** between racking **eliminated**.



This storage concept consists of a set of racking units which form an internal lane with support rails for the pallets. The forklift enters the lane with the load elevated above the support rail that it will be placed upon.

Guide rails facilitate forklift manoeuvres, aiding movement and minimising the possibility of accidental damage.



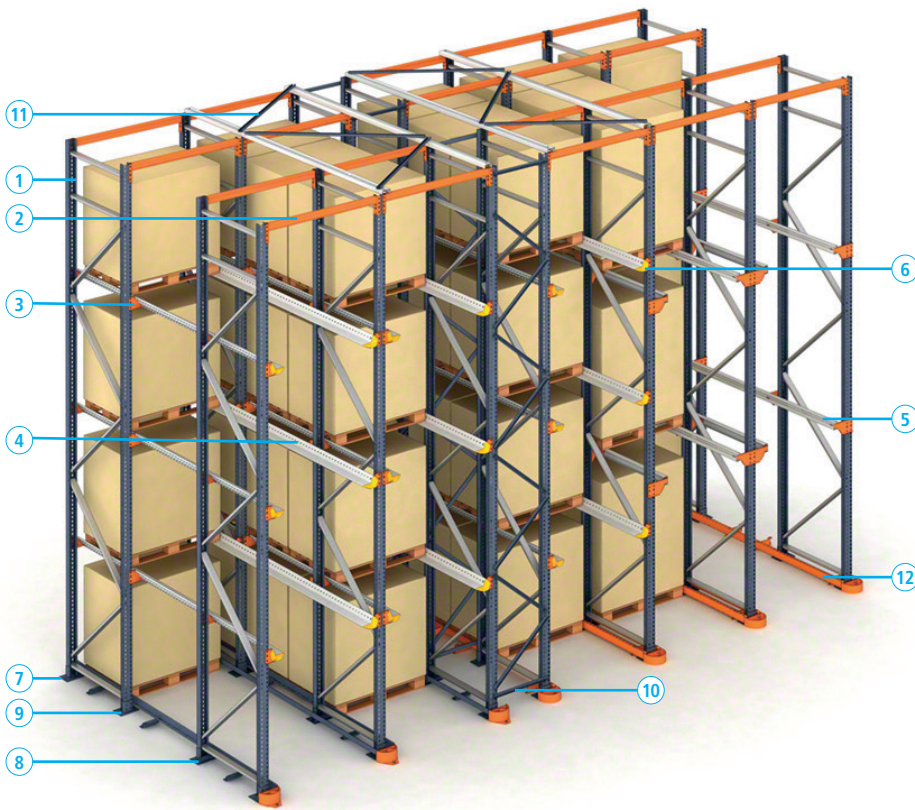

1. Frame
2. Drive-in beam
3. Rail bracket
4. GP rail
5. C-rail section
6. Pallet centraliser
7. Upright footplate
8. Shim
9. Anchor bolts
10. Bracing set
11. Upper cross bracing
12. Guide rail and protector (optional)



Pallet centraliser



GP rail

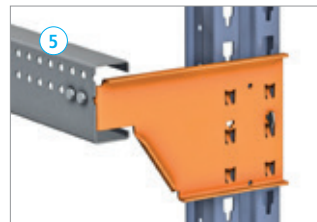

C-rail section

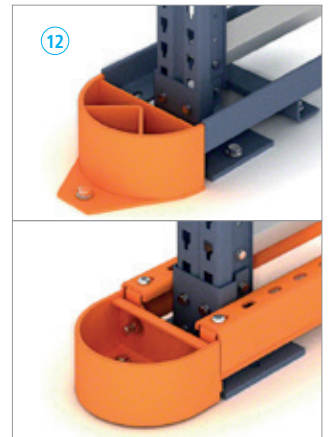

Guide rail and protector



Semi-automatic Pallet Shuttle

- ✓ **Compact** and high capacity warehousing.
- ✓ **Reduces** loading and unloading **times**.
- ✓ **Larger number of stored product types** (one product type per channel).
- ✓ **Lower risk** of accidents.
- ✓ **Less damage** to racking units.
- ✓ Ideal for **cold storage** warehouses.



This is a high-density pallet storage system which facilitates the independent loading and unloading of goods from an electric shuttle called a Pallet Shuttle, eliminating the need for forklifts to enter the racking.

The forklift places the load onto the rails at the entrance of the channel and the Pallet Shuttle picks it up and moves it along the rails before depositing it in its assigned location.

The forklift operator controls all storage and extraction movements using a Wi-Fi device. The latter is capable of controlling up to 18 shuttles.



Structural components

1. Post
2. Crossbeam
3. Track
4. Exterior track support
5. Interior track support
6. Track bumper
7. Centraliser

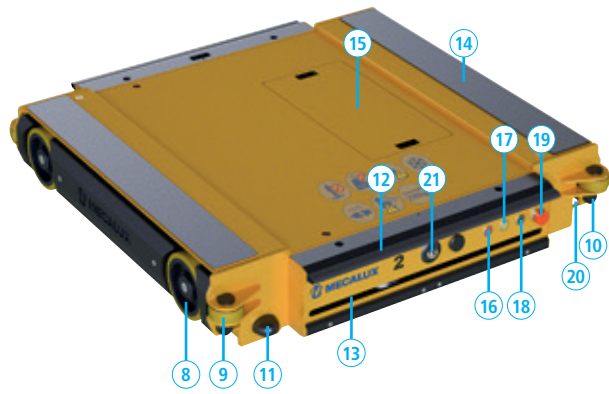
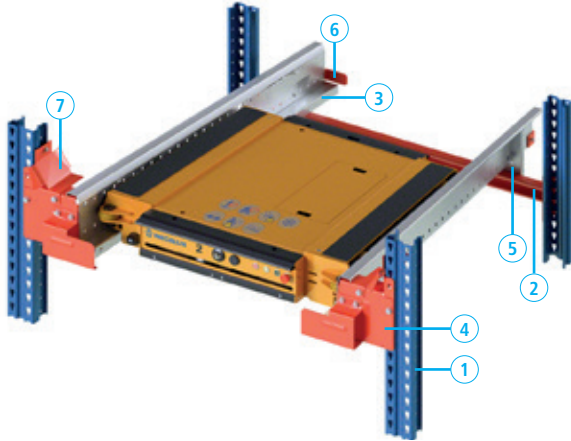

Shuttle components

- | | |
|--|--|
| <ol style="list-style-type: none"> 8. Wheel 9. Contrast wheel 10. Bumper 11. Antenna 12. Safety bumper 13. Safety scanner (optional) 14. Lifting platform | <ol style="list-style-type: none"> 15. Battery compartment 16. Fault indicator 17. Battery status indicator 18. On/Off switch 19. Emergency stop button 20. End-of-track sensor 21. Positioning camera (optional) |
|--|--|



STEP 1
A forklift places a Pallet Shuttle on the level where goods are going to be stored.



STEP 2
The forklift loads the pallets one by one at the level's entrance, supporting them on the loading sections.



STEP 3
The shuttle raises one pallet slightly and then rolls horizontally until reaching the first open location where it then sets the pallet down.



STEP 4
The shuttle returns to the lane entrance to repeat the procedure with the next pallet and continues successively until the lane is full. Once the last location is filled, the shuttle is extracted, ready to work on another level.

To extract pallets, the procedure is the same, except in reverse order.



Live pallet racking

- ✓ Enables **perfect turnover** of stored products (FIFO system, the first pallet to be put in is the first to be taken out).
- ✓ **Optimum stock control**. Only one product type is stored in each channel.
- ✓ **Saves time** in pallet handling.
- ✓ **Maximum capacity**.
- ✓ Separate aisles for loading and unloading **eliminate interference** while processing orders.



Live storage racking features roller tracks on a sloped lane to allow pallets to slide over them.

The pallets are placed at the highest point of the rolling section and then move by the force of gravity at a controlled speed towards the other end, ready to be removed.



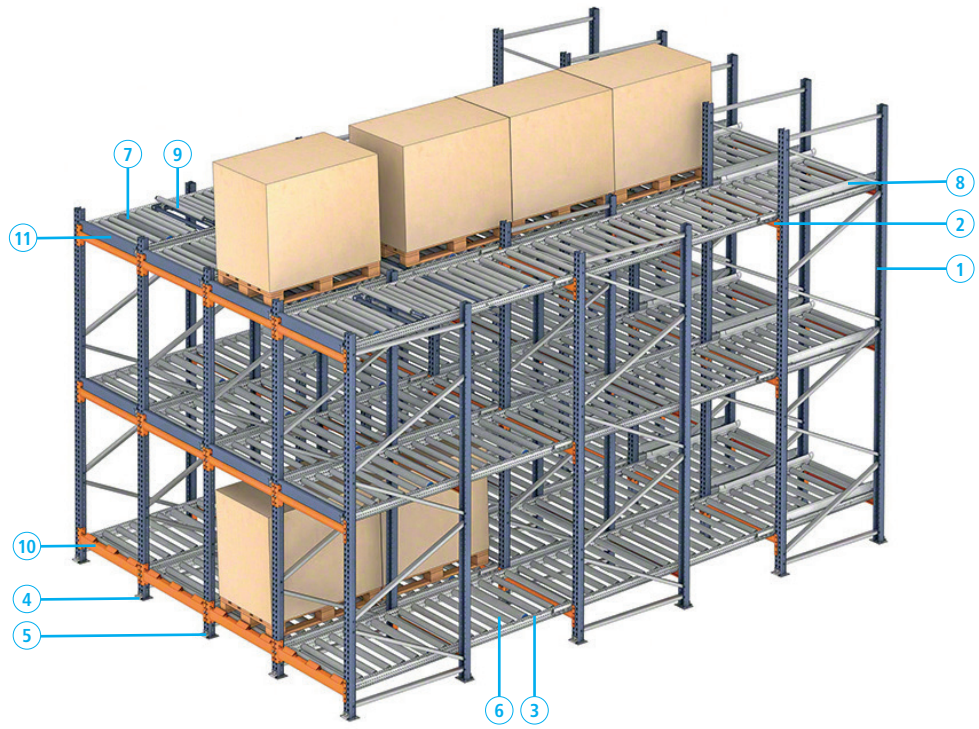

1. Frames
2. Live crossbeam
3. Profile
4. Levelling plates
5. Anchor bolts
6. Rollers
7. Brake roller
8. Centralising strips
9. Pallet retainers (optional)
10. Exit beam
11. End stop

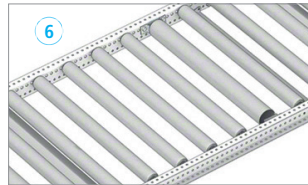

Rollers



Brake roller



Centralising strips

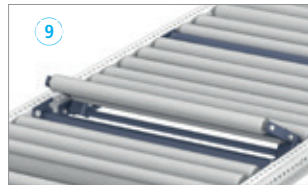

Pallet retainers

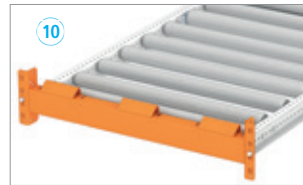

Exit beam

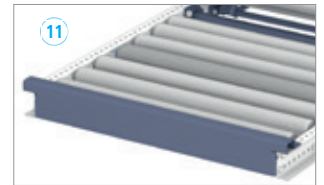

End stop

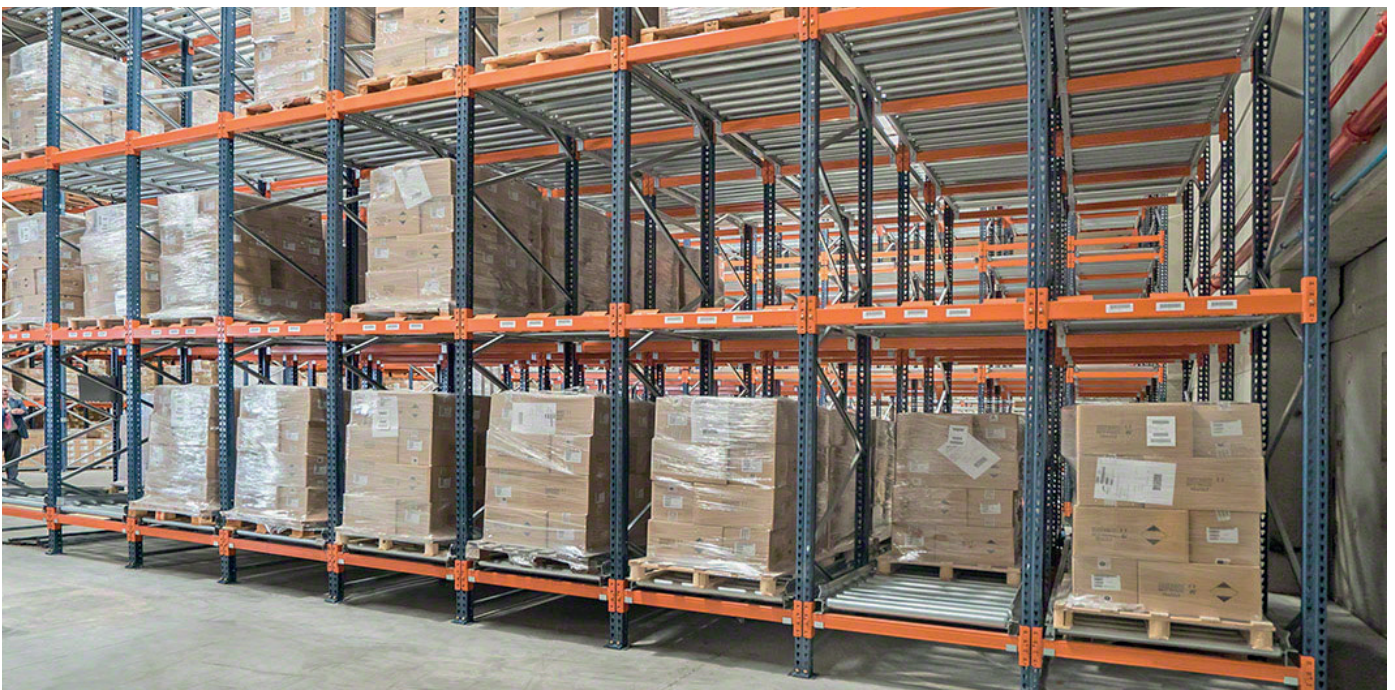

Push-back pallet racking

- ✓ **Optimal use** of available space.
- ✓ Ideal for **storing medium turnover products**, with two or more pallets per SKU.
- ✓ The specially designed system means that **very little height space is wasted**.
- ✓ Unlike other high-density systems, **each channel can store a different product type**.



Push-back is an accumulative storage system that allows you to store up to four pallets deep per channel. All of the pallets on each channel, except the last, are placed on a set of trolleys that are pushed along the rolling rails. These rails are built on a slight incline, lower at the front, so that the pallets at the back move forward when the pallet closest to the aisle is removed. All the pallets placed on a particular level must contain the same SKU and are managed using the Last In First Out (or LIFO) system.



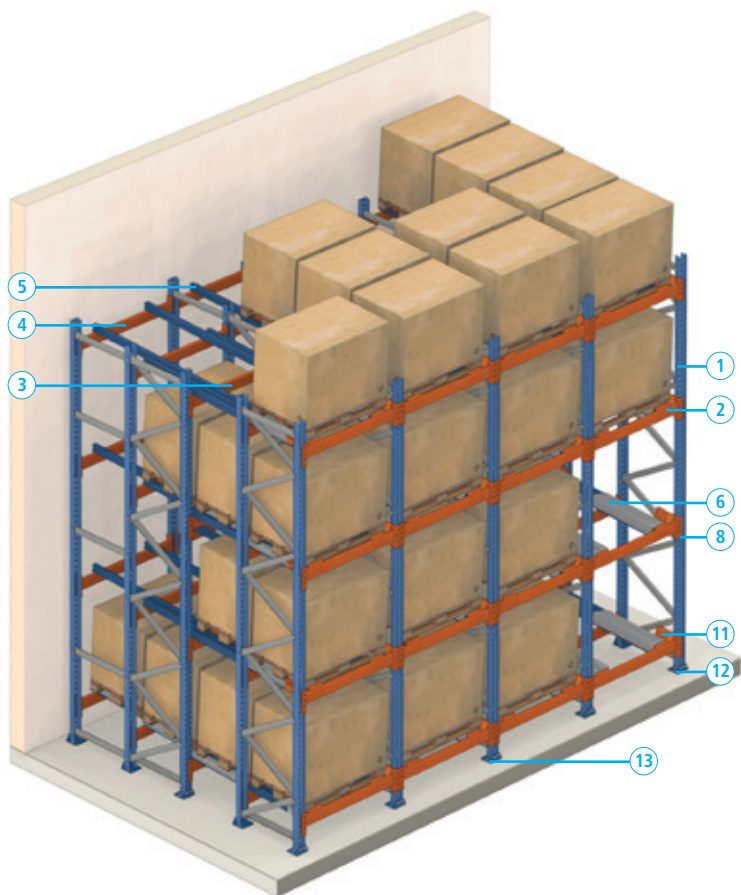

Trolley and rail support

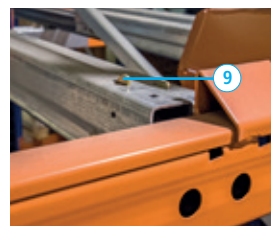

Lock trigger



Trolley occupancy indicator



Pallet centraliser

- | | |
|----------------------|---------------------------------|
| 1. Frame | 8. Safety locking mechanism |
| 2. Front beam | 9. Lock trigger |
| 3. Intermediate beam | 10. Trolley occupancy indicator |
| 4. Top beam | 11. Pallet centraliser |
| 5. Rail | 12. Supplementary plate |
| 6. Trolley | 13. Anchorage |
| 7. Rail support | |

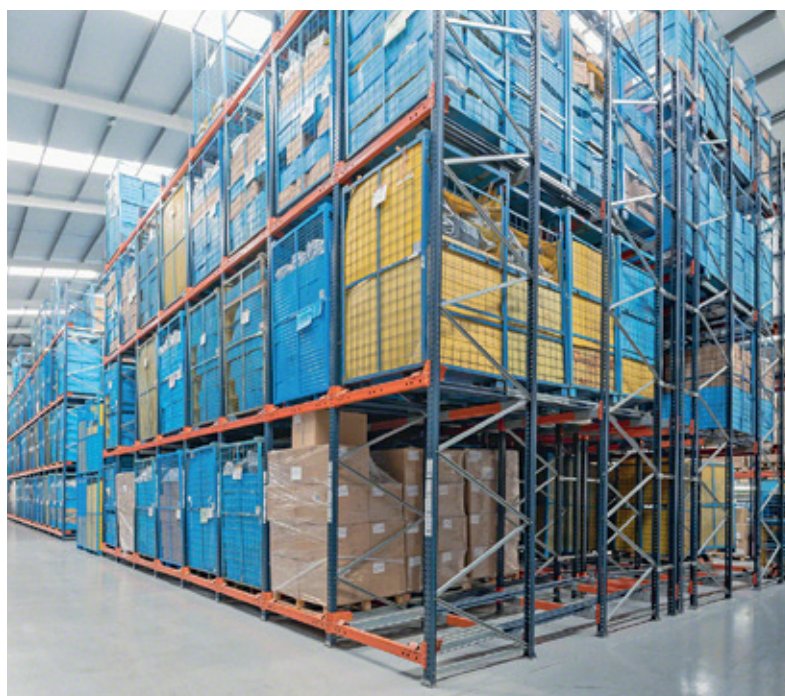

Clad-rack warehouses

- ✓ Great works of engineering in which the racking forms the structure of the building.
- ✓ Enables maximum use of available surface area without wasting space.
- ✓ Allows a wide range of goods to be stored: pallets, containers, bulky packages and very heavy loads.



The clad-rack warehouse is the ideal solution for stacking goods high, as its design ensures the racking structure forms a compact unit along with the roofing and the cladded walls of the warehouse, removing the need for building work.

In these works of engineering the racking supports not only the entire structure and stored goods, but also the movements of the handling devices and external factors including wind, heavy snowfall, seismic activity, etc.

Furthermore, the only limitation to the height of these buildings is either due to local regulations or the handling devices to be used.

These warehouses allow for differing degrees of automation to guarantee optimal performance.



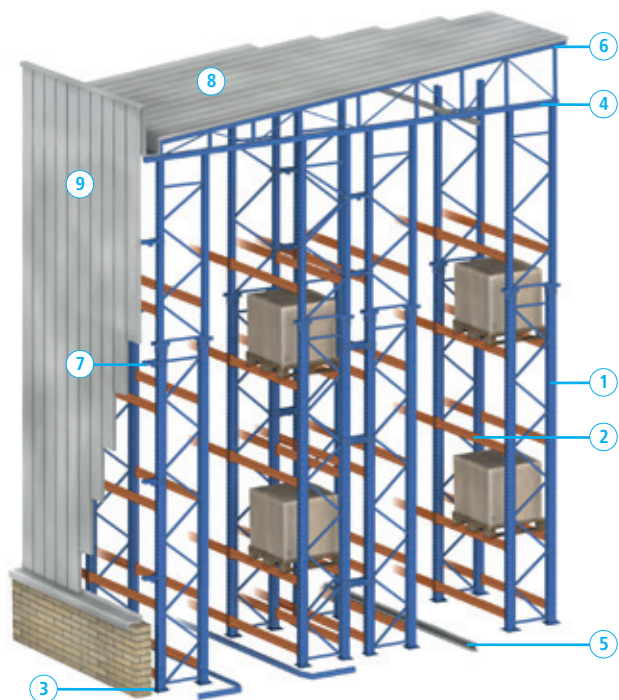

1. Frame
2. Beam
3. Footplates and anchor bolts
4. Roof trusses
5. Guide rails
6. Roof joist
7. Wall joist
8. Roof
9. Cladded walls

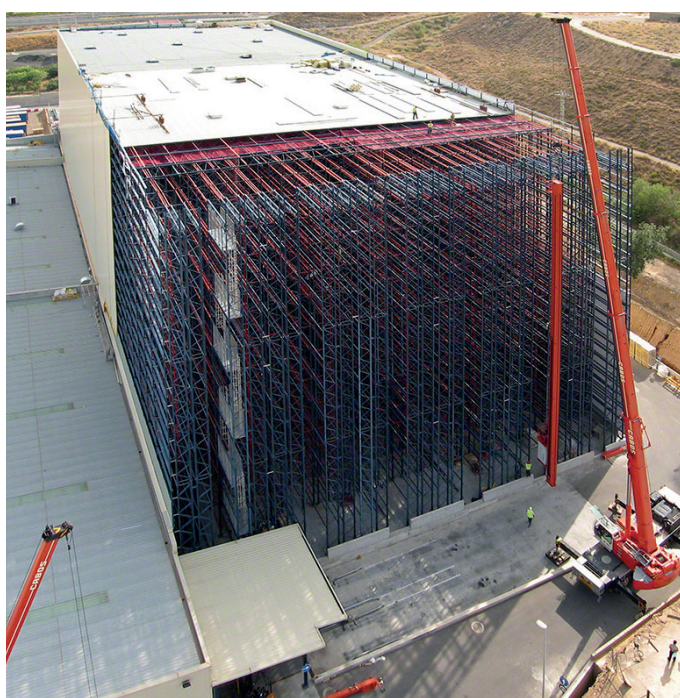

Automated warehouses for pallets

- ✓ Automation of product entry and exit operations.
- ✓ Elimination of any possible errors arising from manual operation.
- ✓ Real-time stock management.



Mecalux identifies the client's need and the required flow of stored goods in order to design the most appropriate installation.

In addition, Mecalux prepares the preliminary plans and manages the process from start to finish, taking care of the design, legal requirements, planning, assembly and completion of the installation. This means that the client only has to communicate with one agent throughout the entire project.

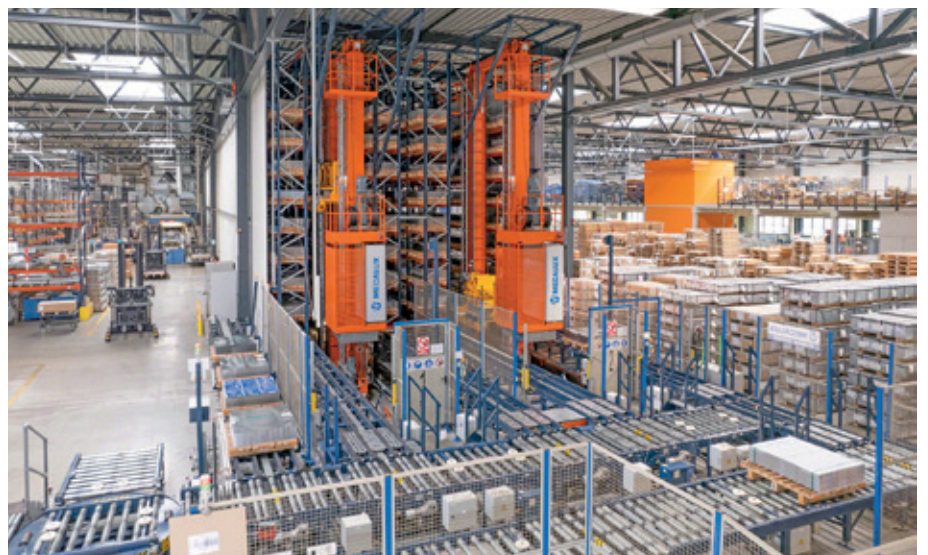

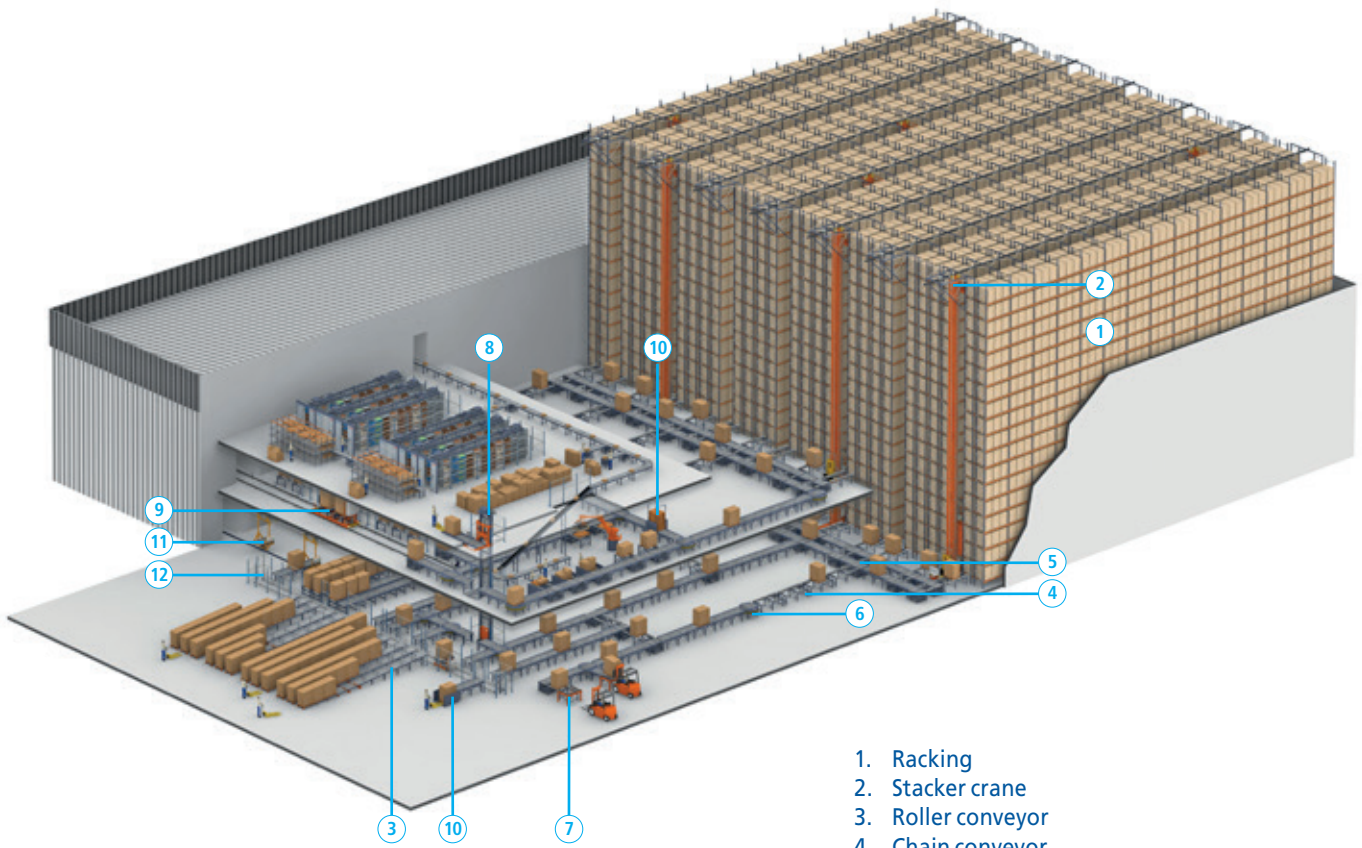

1. Racking
2. Stacker crane
3. Roller conveyor
4. Chain conveyor
5. Cross transfer conveyor with rollers and chains
6. Turntable conveyor
7. Input/output chain conveyor of the warehouse
8. Pallet lift
9. Transfer car
10. Pallet stacker / unstacker
11. Electrified monorail system
12. Safety and protection measures



Stacker cranes for pallets

- ✓ **Easily adaptable** to the needs of every warehouse in terms of load capacity, dimensions, design and cycle times.
- ✓ **Guided by management software** that coordinates all movements in the warehouse.
- ✓ **Automated extraction** of pallets in single, double or triple depth.



Stacker cranes are machines designed for the automated storage of materials by means of automatic mechanical movements. Materials are inserted and extracted at the same time (known as a combined cycle). This increases the productivity of the installation and also reduces the resources required for it to function.

They are guided from above by a profile placed on the racking and from below by a rail which is anchored to the floor.

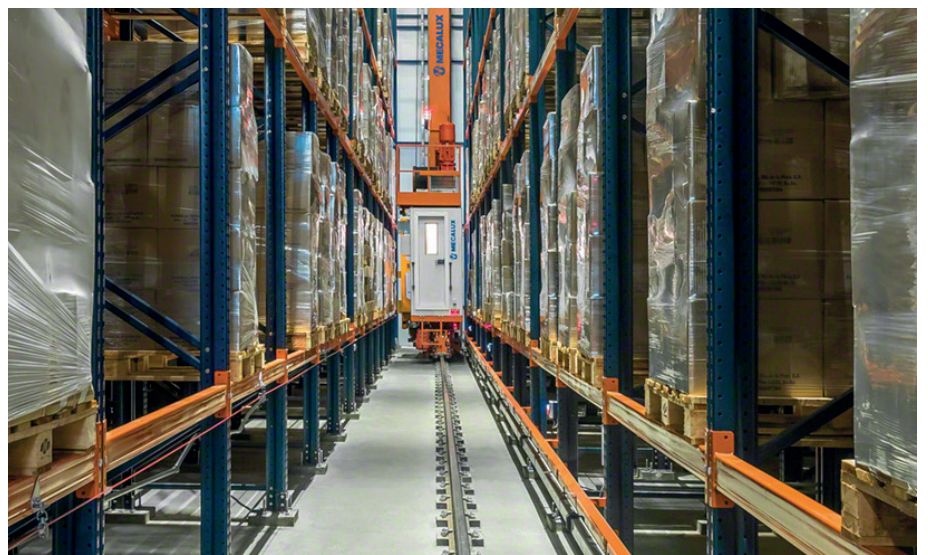

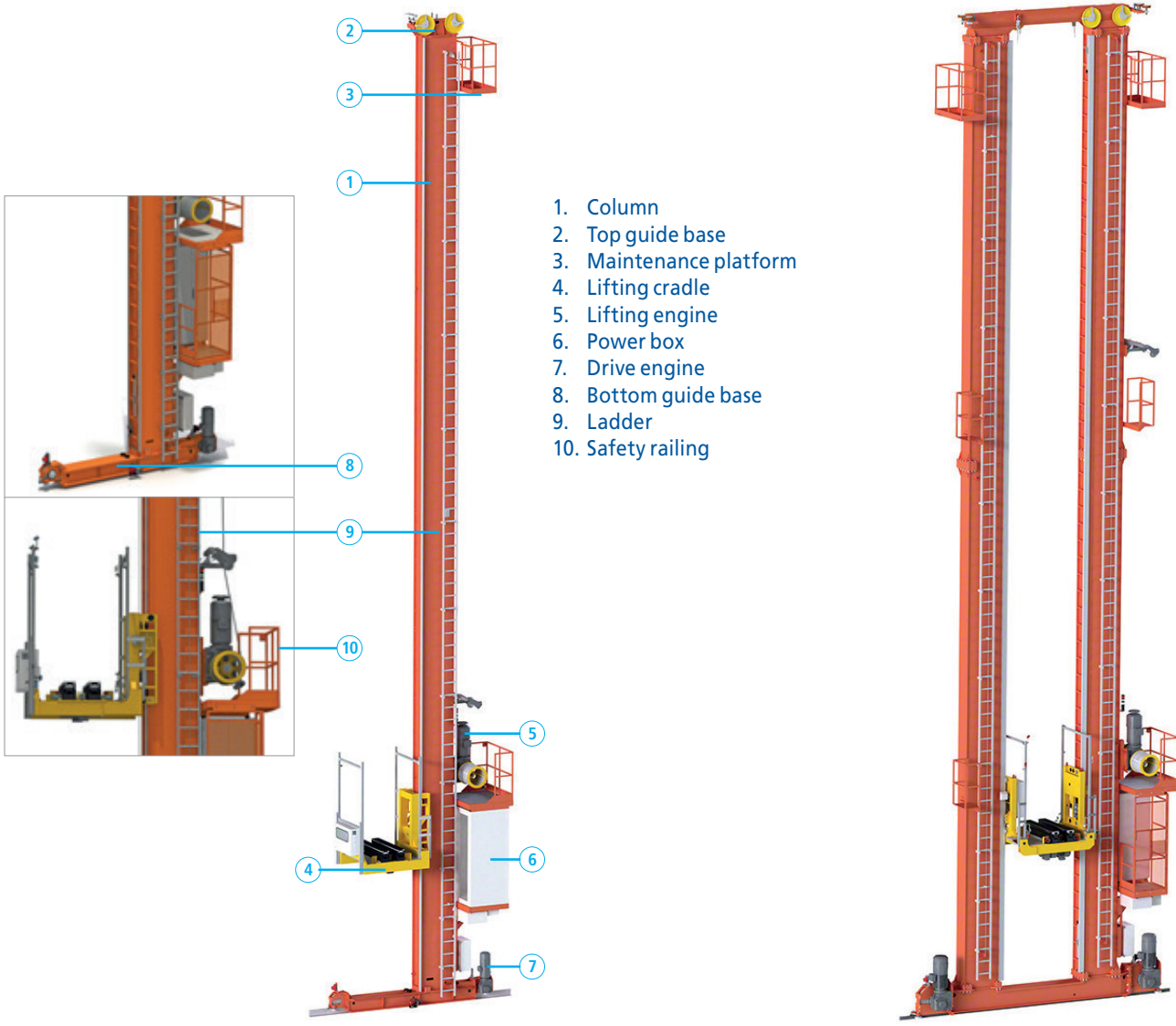

Automatic Pallet Shuttle

- ✓ **Greater storage capacity.**
- ✓ **Automated management.** Eliminates errors.
- ✓ **Enhanced productivity.** Large increment in the number of cycles/hour.
- ✓ **Cost savings.** Decreased surface area to build, lower labour and power costs.
- ✓ Possibility of grouping **a different SKU in each storage channel.**
- ✓ **Decreased risk of accidents** and absolute control of goods.



This system involves the incorporation of automated equipment in the handling processes of high-density warehouses. As a result, the forklifts are replaced by stacker cranes or transfer cars carrying the Pallet Shuttle and the load in their cradle.

The shuttle is introduced into the storage channels and positions each pallet in the innermost free space available, following the orders issued by the Easy WMS warehouse management software from Mecalux.



Structure

1. Upright
2. Beam
3. Rail
4. Inner rail support

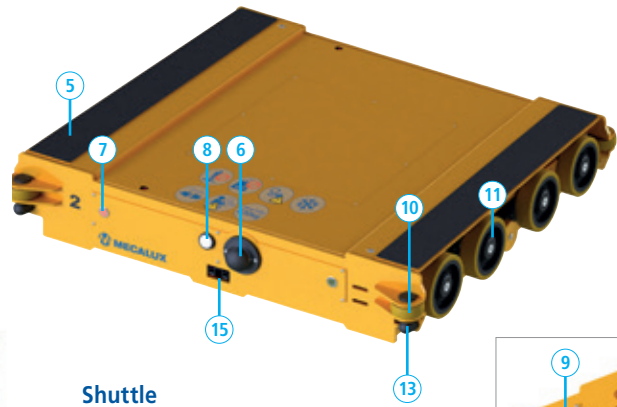
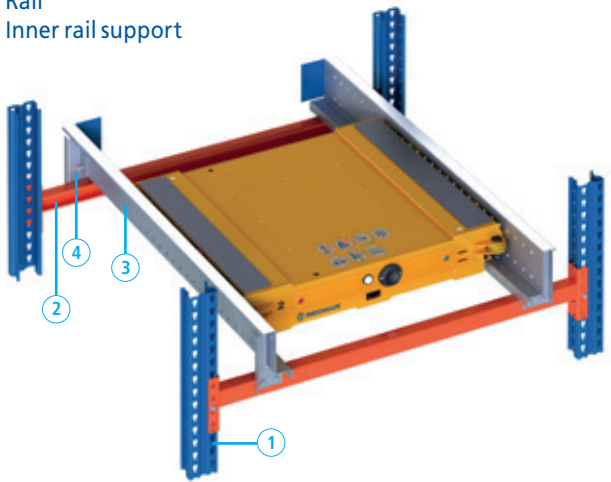

Shuttle

5. Lifting platform
6. Aerial
7. Fault indicator
8. Ultrasound sensors
9. On/off switch
10. Contrast wheel
11. Wheel
12. End-of-track sensors
13. Rubber stop
14. Automatic battery connectors for supercapacitors
15. Power plug for supercapacitor discharge

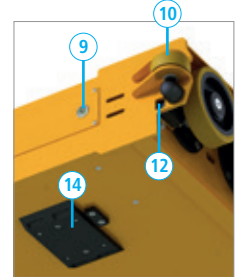

Automatic Pallet Shuttle installation with stacker crane

The stacker crane carries out movements from the input and output positions in the warehouse to any storage channel. The Pallet Shuttle is tasked with moving the pallets from the cradle of the stacker crane to the location in the corresponding channel. Generally, two high-density storage racking blocks are installed, one on each side of the working aisle.

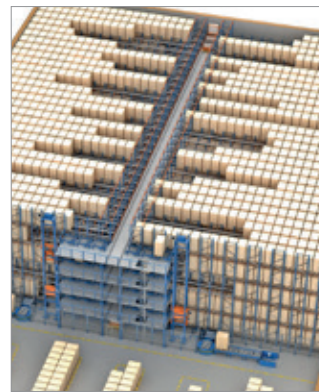

Automatic Pallet Shuttle installation with transfer car

A gangway type structure is installed that allows the movement of a transfer car on each level, whose task is to carry out movements from the lifts to the storage channels of each level. Thus, the number of movements or cycles/hour is multiplied by the number of levels in a warehouse, combining high capacity with a large number of movements.



Automatic trilateral stacker cranes

- ✓ The perfect solution to **automate pallet racking** up to 15 metres high.
- ✓ **Easy to implement.** No need to modify the warehouse structure.
- ✓ **Trilateral extraction** integrated system.
- ✓ **Decreases personnel costs and reduces errors.**
- ✓ **Improves safety in the facility.**
- ✓ **Low maintenance costs.**

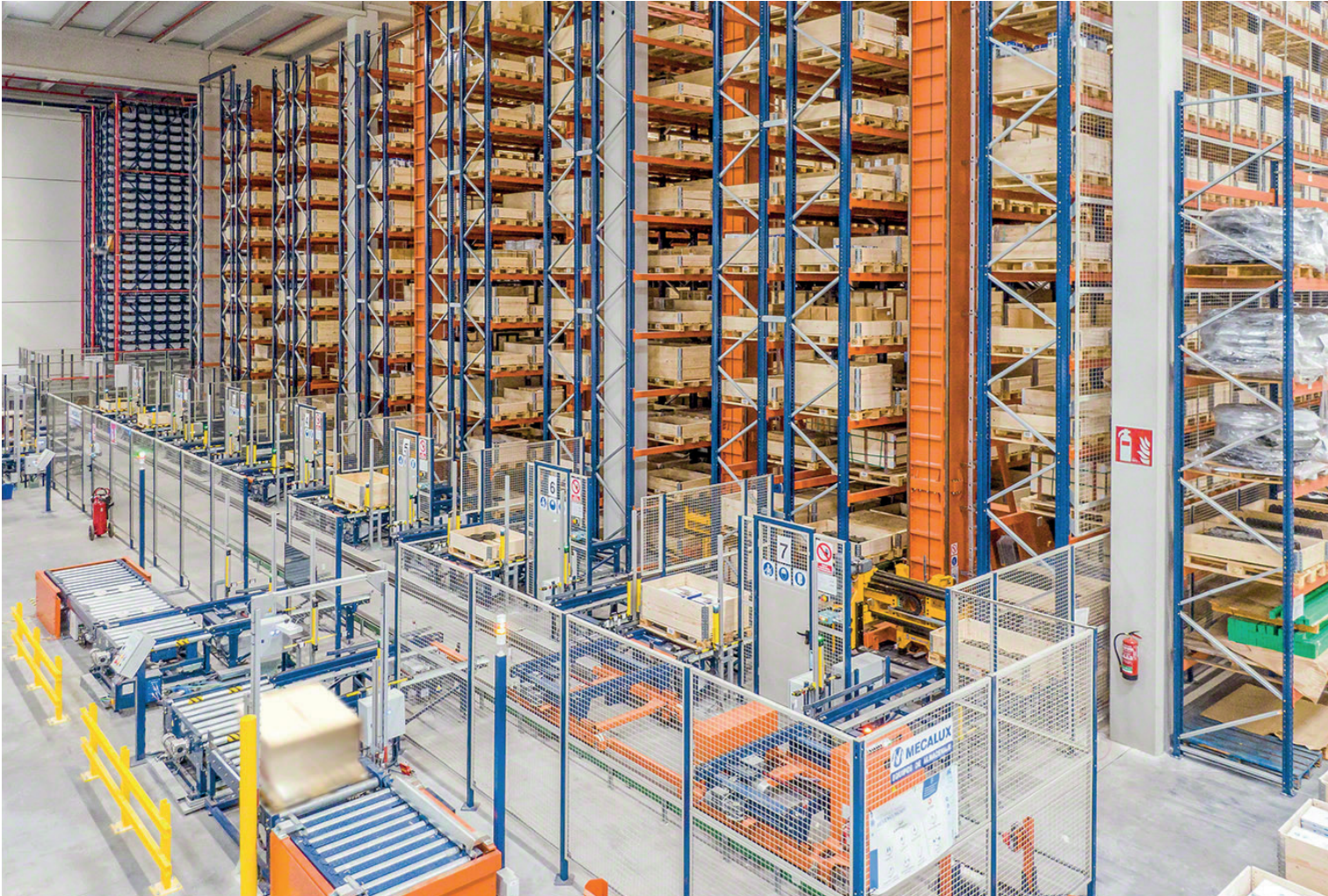

Automatic trilateral stacker cranes make it very easy to automate warehouses with conventional racks where a manually operated lift truck is used, both in pre-existing warehouses and in new facilities.

The stacker crane moves pallets to the ends of the passageway, leaving the load on a rack or automatic transport system. This is possible as it has a rotating head enabling it to pick-up and leave pallets in three positions: one frontal and two lateral.



It consists mainly of three parts:

Bottom guide base. This supports the whole structure and moves it longitudinally.

Column. This element allows the crane to reach all different heights.

Extractor element. Trilateral fork moved by a head that can travel left, right and forward to access the load.

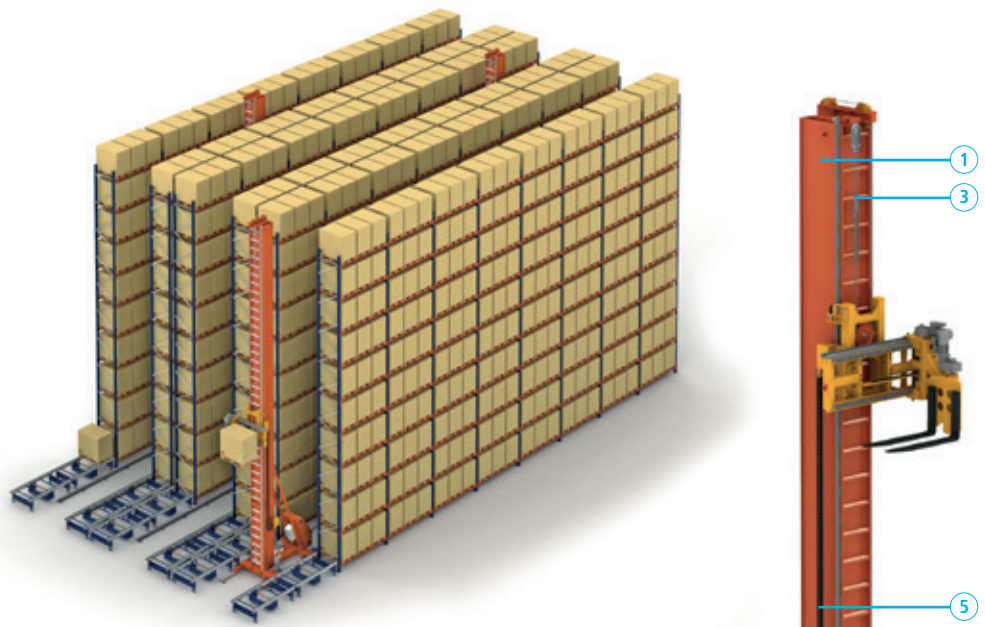

- | | |
|-------------------------|------------------------------|
| 1. Column | 6. Cross bracing |
| 2. Bottom guide base | 7. Electrical cabinet |
| 3. Lifting cable | 8. Gearmotor for lifting |
| 4. Trilateral extractor | 9. Gearmotor for travelling |
| 5. Cable carrier | 10. Gearmotor for extraction |

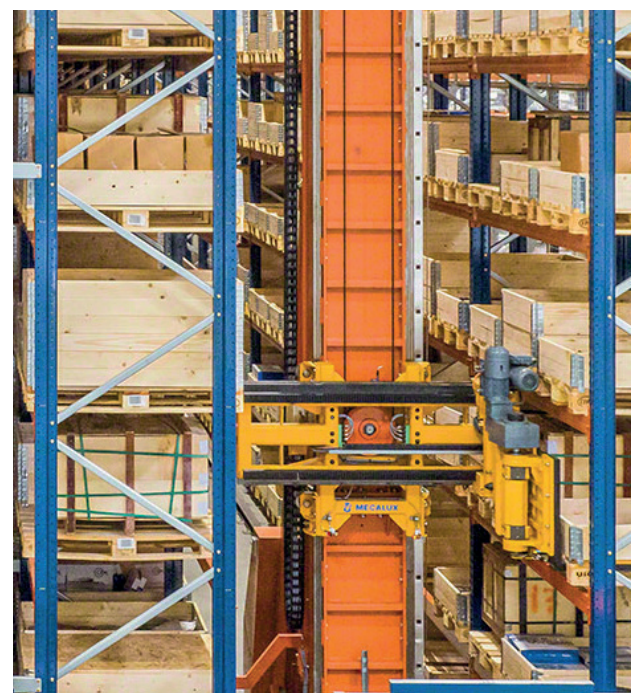
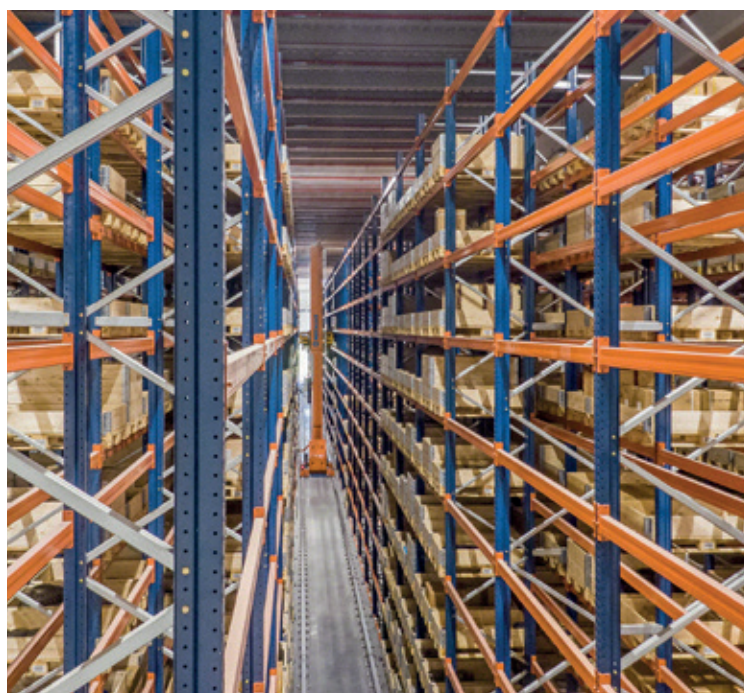
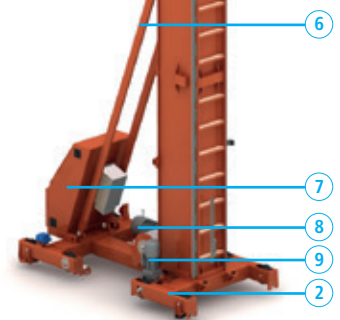
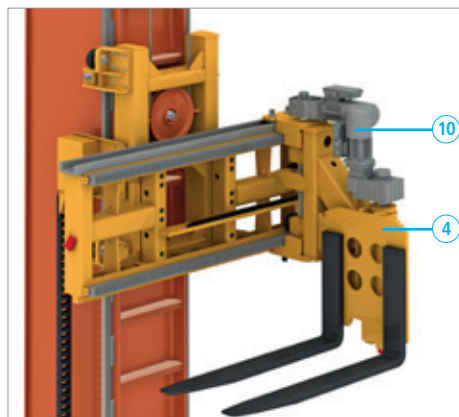
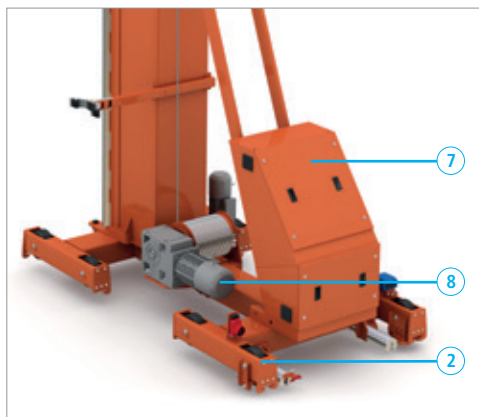

Conveyor systems for pallets

- ✓ **High productivity** in inserting and extracting products.
- ✓ **Reduction of mistakes and accidents** in the facility thanks to the automation of materials handling.
- ✓ **Wide range of items** that allow different combinations.
- ✓ Maximum **standardisation of the measures and components** of the conveyors.



Conveyor systems represent an ideal combination between the efficiency of the stacker cranes and the entry, dispatch and handling processes of the load units. Logistics operations require a continuous flow of materials, as pallets and/or boxes must be taken from a storage or production location or from an overflow warehouse to dispatch or production areas.

Conveyors are static transport devices that have a series of rollers, chains and belts. Electric-powered motors move the pallets or boxes in a regulated and continuous manner.

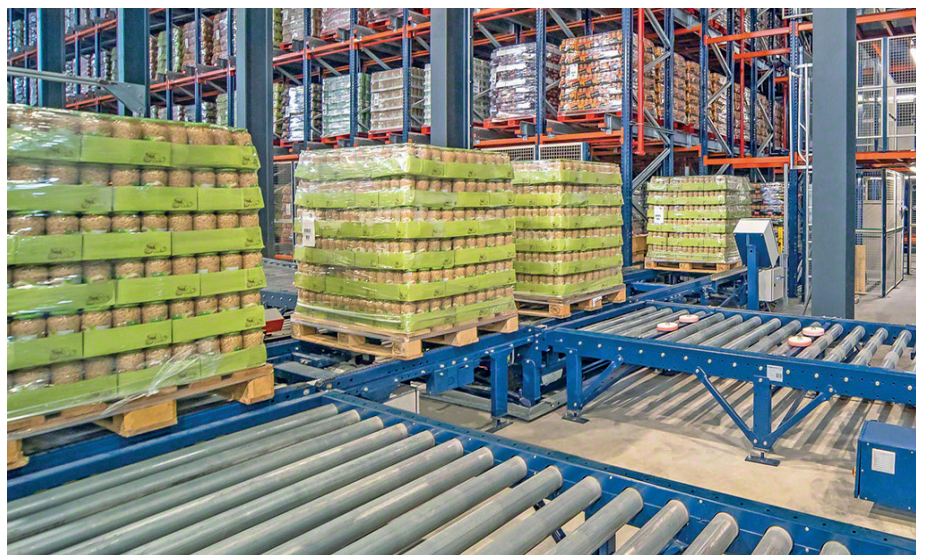

Here are some examples of our conveyors:

1. Roller conveyor
2. Chain conveyor
3. Pallet check unit (PCU)
4. Pallet lift
5. Turntable conveyor
6. Cross transfer conveyor with rollers and chains
7. Transfer car
8. Chain conveyor for side loading
9. Roller conveyor for front loading
10. Lift table
11. Pallet stacker

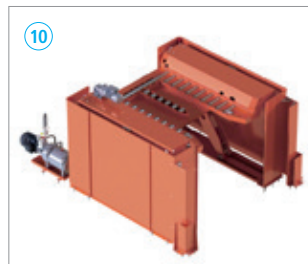
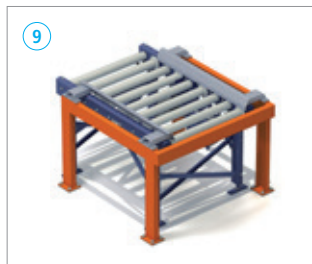
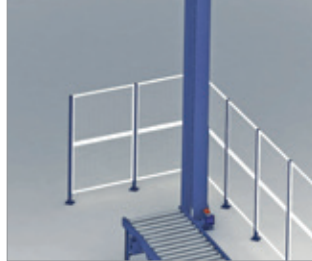
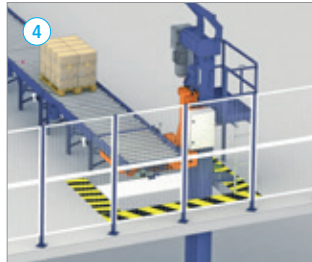

M7 Longspan shelving

- ✓ Optimal solution for manual storage and archiving of **different products**.
- ✓ Ideal for storing **bulky** or **heavy items**.
- ✓ **Adjustable load levels**.
- ✓ A wide range of **components adaptable** to your needs.



Longspan shelving is designed for warehouses where goods are deposited and removed manually from shelves. This system also makes optimal use of warehouse height, as the higher levels can be accessed mechanically by devices that lift the operator to the required height (stacker cranes or order picking forklifts) or via gangways located between shelves.

It is also common practice to set up a mixed warehouse of picking and pallet storage, where the top shelves are used to keep palletised reserve stock and the bottom is set aside for picking.



1. Frame
2. Beam
3. Galvanised picking shelf
4. Chipboard shelf
5. Mesh shelf
6. Chipboard cross-tie
7. Mesh shelf cross-tie
8. Safety pins
9. Frame union
10. Z-TAM Clamp
11. Shim (levelling plate)
12. Anchor bolt (if applicable)



Units for hanging products.
There are two solutions for hanging garments or other articles: one formed by hanger tube beams and another in which shelf levels are combined with supports and hanger tubes.

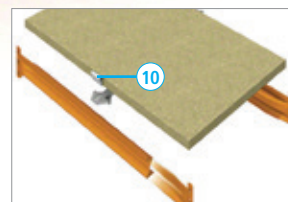
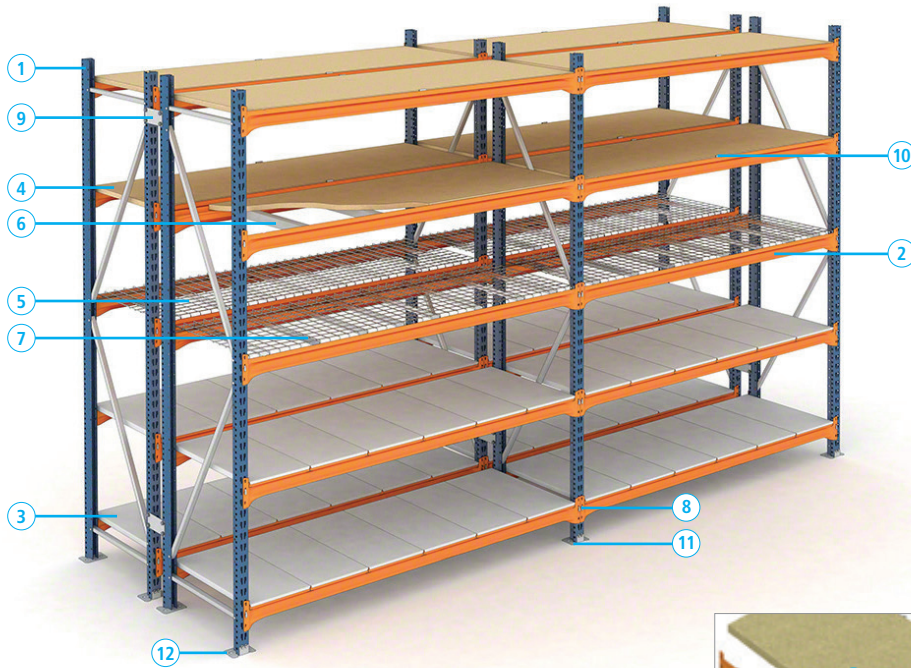

Chipboard Z-clamp



Chipboard shelf



Racks for picking with gangways

- ✓ **Maximise the use of warehouse's height.**
- ✓ **Possibility of installing** one or more gangways.
- ✓ **Accessibility to different levels** via stairs.
- ✓ Gangways may be placed on **any existing rack model.**



The full use of the warehouse's height is enabled, installing high racks with one or more gangway levels supported by the racks themselves.

Entry onto the different gangway levels is done via stairs, installed in appropriate locations depending on accessibility and safety.

In addition to the stairs, goods lifts or lifting platforms can be installed.

There are different types of flooring (wood, slotted metal, perforated...) to suit different needs.



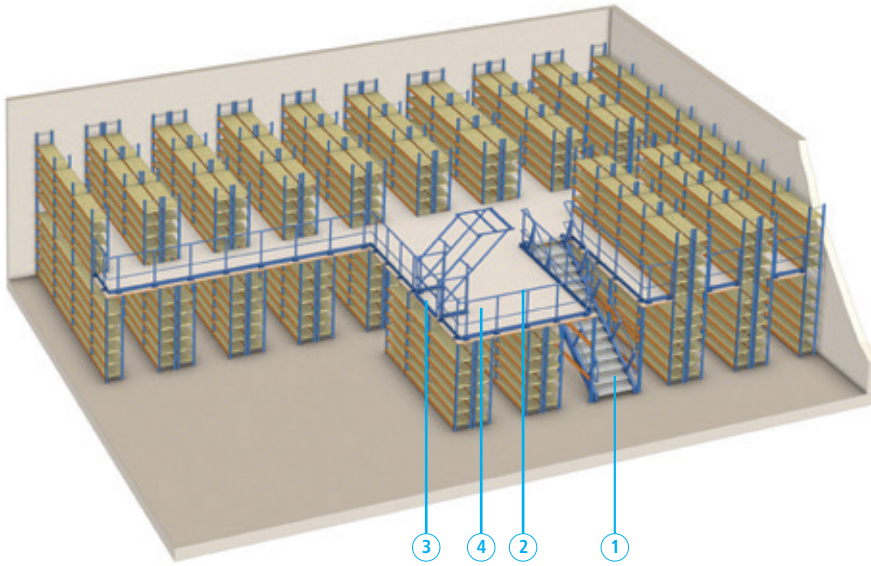

1. Stairway
2. Railing
3. Up-and-over gate
4. Floor



Up-and-over gate



Stairways. The stairs designed by Mecalux are easy to assemble, resistant and adaptable to different heights.



Railings. Protective rails are built with round and rectangular tubes that are joined together. Protective skirting is fitted to its base to prevent objects falling from the mezzanine floor.



Hinged door



Sliding door



M3 shelving

- ✓ **Basic system of manual storage** and archiving for light and medium loads.
- ✓ **Multiple modules** that adapt to the most demanding requirements.
- ✓ Possibility to install one or more **gangways to gain access to upper levels**.
- ✓ **Easy to assemble**.



Made up of vertical structures and panels or horizontal shelves that permit the storage of small boxes or goods in separate sections.

Various accessories allow for the division of levels and placement of boxes to classify individual products, folders, etc.



1. Frame (5 models)
2. Shelf (2 models)
3. Shelf supports
4. Cross bracing set
5. Frame union
6. Footplate (2 models)
7. Back panels
8. Frontpieces
9. Plinths
10. Vertical dividers
11. Drawers
12. Doors
13. Suspension file fitting
14. Garment rail set
15. Side hooks
16. Magnetic label holder

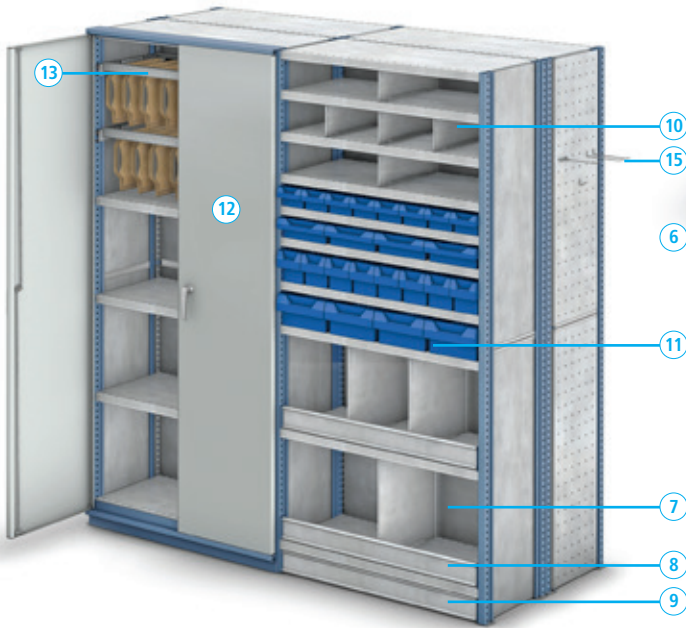
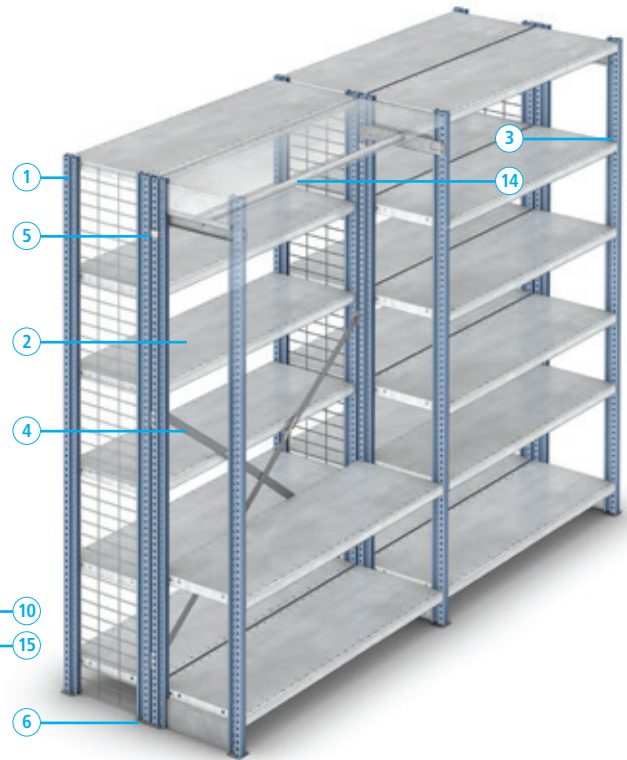

HM metal shelves



HL metal shelves



Live storage for picking

- ✓ **FIFO system** (the first box in is the first box out) enabling perfect product turnover.
- ✓ **Higher number of SKUs** at the front of the racking.
- ✓ **Reduction in time** needed for order preparation.
- ✓ **Higher storage capacity** in the facility.



Live storage for picking. Goods are placed onto sloped roller tracks where they then roll at a controlled speed towards the lane exit by the force of gravity.

This guarantees perfect product turnover, prevents interference in stock replenishment, and increases the speed of order preparation. To speed up the collection of material, pick-to-light devices managed by warehouse management system can be incorporated.



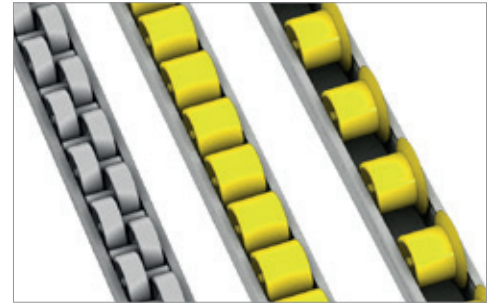
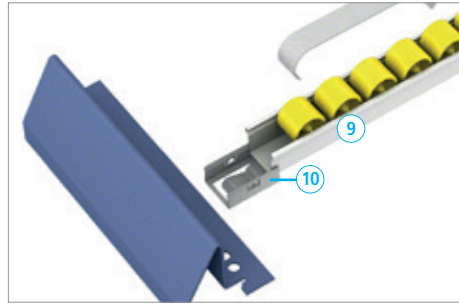
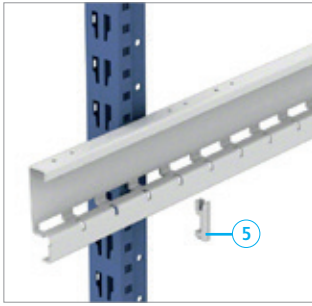

Mini-rails

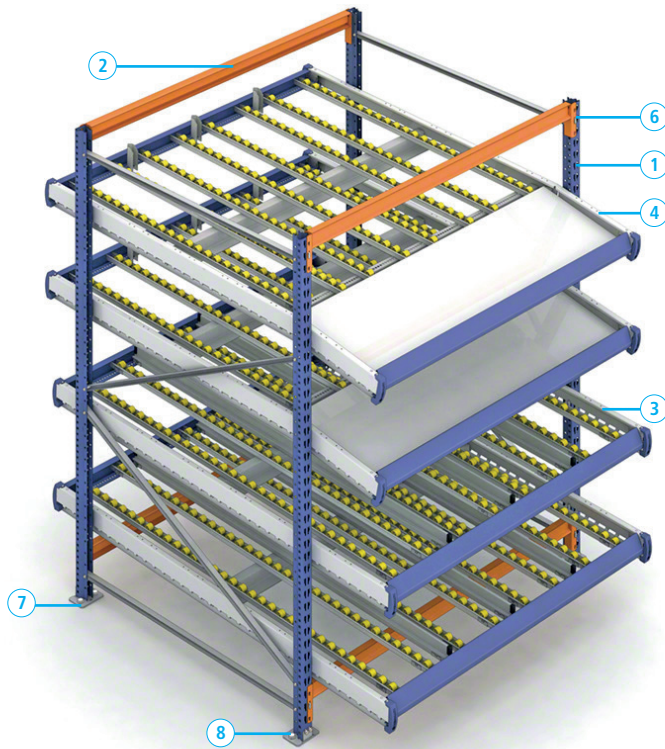

1. Frame and upright
2. Beam
3. Standard beds
4. Beds with display trays
5. Rail supports
6. Safety pins
7. Anchor bolts
8. Levelling shims
9. Mini-rails
10. Mini-rail clips



Automated warehouses for boxes

- ✓ **Automation** of product entry and exit operations.
- ✓ Increased **productivity**.
- ✓ **Optimal use** of available space.
- ✓ **Elimination of errors** arising from manual management of the warehouse.
- ✓ **Real-time inventory**.
- ✓ Maximum **comfort and easy access** to the stored boxes.



Optimal for storage and picking in accordance with the "product-to-person" principle. These warehouses consist of one or more aisles with racking on both sides for storing boxes or trays. A stacker crane moves up and down each aisle, moving and depositing boxes into their location. The pick-up and delivery area consists of conveyors where stacker cranes deposit loads extracted from the racking. This is located at one end or next to the racking. The conveyors carry each box to the operator before returning the box to the stacker cranes to be placed in its correct position in the racking.





Racking

Designed to coincide perfectly with the movement of the stacker crane and intended for the storage of boxes by height. Its design allows for a better use of space and increased storage capacity by optimising the movements of the crane.



Stacker crane

This robotic element is responsible for carrying out the positioning and extraction of the boxes in the racking, as well as transporting and placing them on the table at the warehouse's P&D station.



P&D station

The warehouse's P&D station (pick-up and delivery) is located at the side or at the front of the racking. It deals with the mechanical movements needed to bring the boxes closer, either to the operator or to the stacker crane, so they can be picked up and returned to their position in the warehouse.



Warehouse Management System

Runs all the storage operations, optimising use of time and warehouse space. Easy WMS software facilitates the control of processes and provides simple access to all the information.

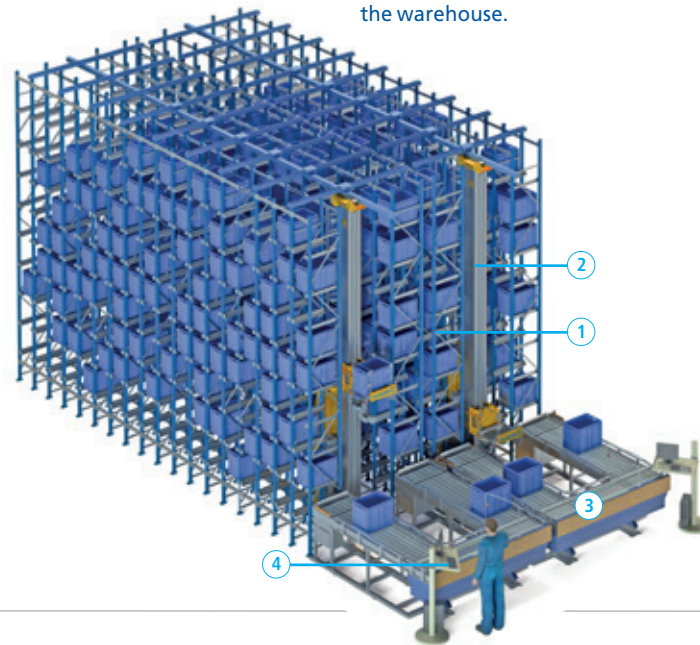

1. Racking
2. Stacker crane
3. P&D station
4. Computer system

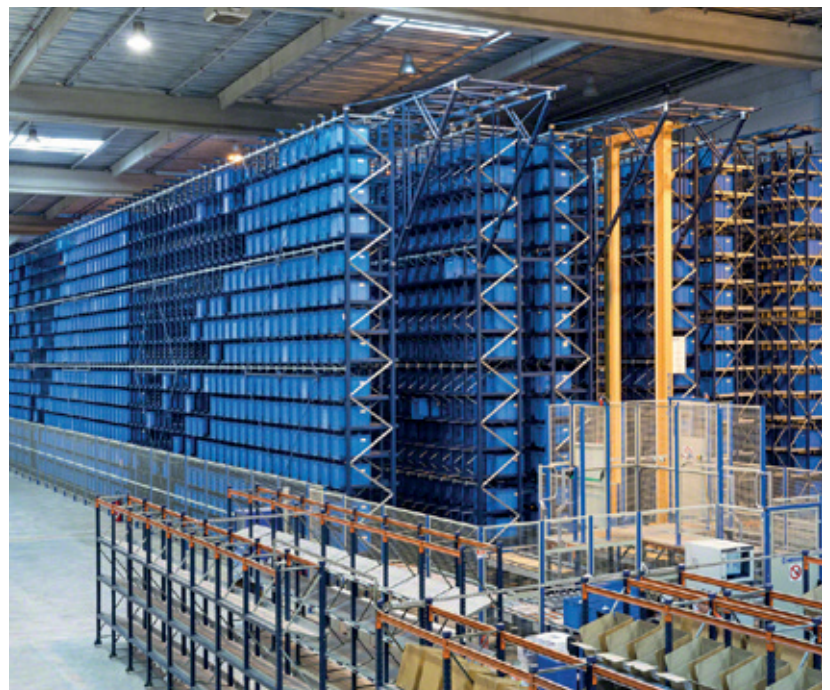

Stacker cranes for boxes

- ✓ **Swift and reliable** handling.
- ✓ **Automation of product entry and exit** operations.
- ✓ **Elimination of errors** resulting from manual management of the warehouse.
- ✓ **Control and update** of warehouse management.

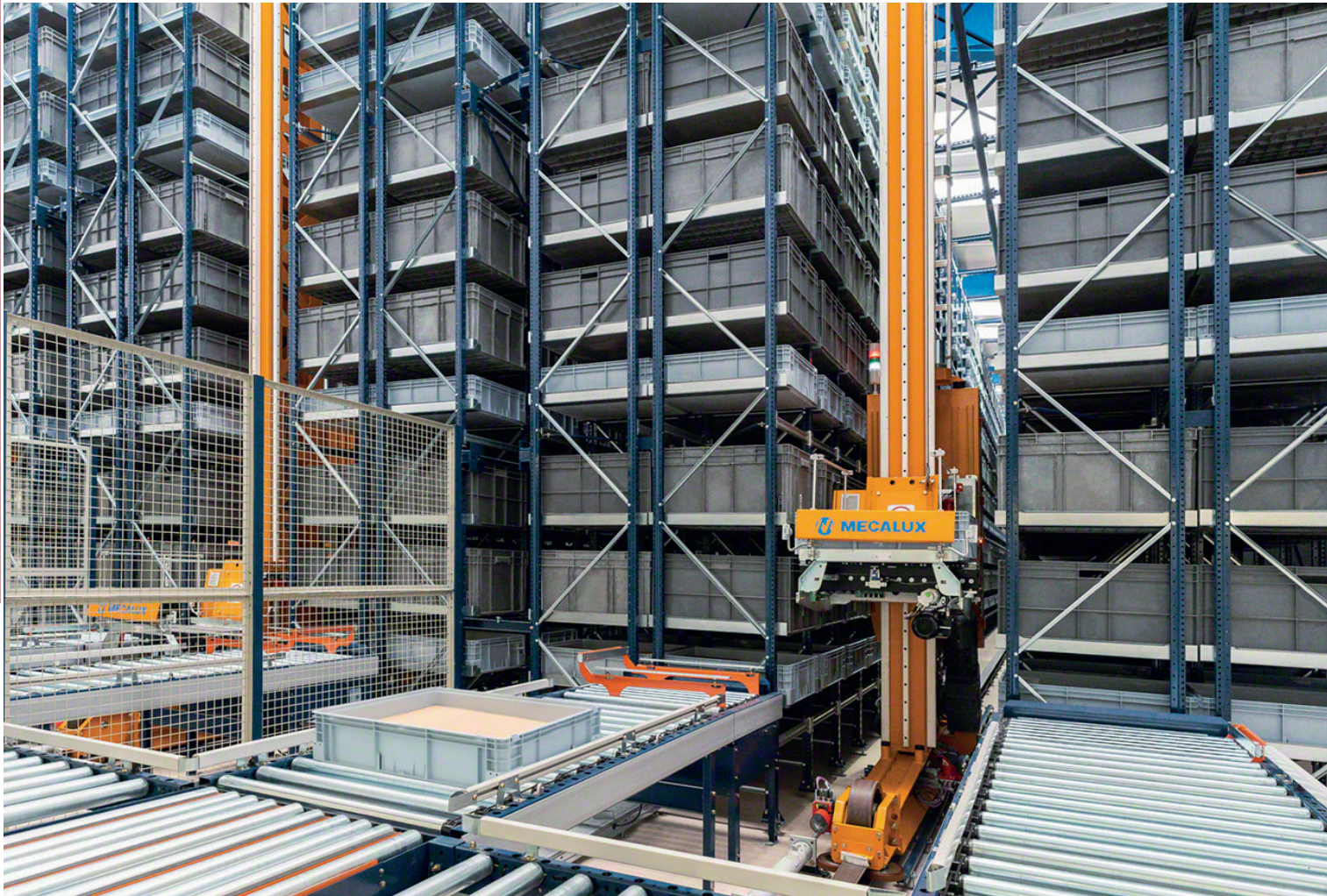

Stacker cranes for boxes are designed to achieve a high level of productivity and manage loads with boxes or trays.

The design of the stacker cranes enables the forces transmitted to the supporting structure to be minimised, thus preventing long-term damage to the racking or the structure of the warehouse.

Mecalux has also equipped its machines with essential ergonomic and safety systems necessary to carry out work orders and maintenance as easily as possible.



1. Bottom guide base
2. Columns
3. Top guide base
4. Lifting cradle
5. Electrical box
6. Lifting mechanism
7. Drive mechanism
8. Cable-free electrical conduction
9. Ladder

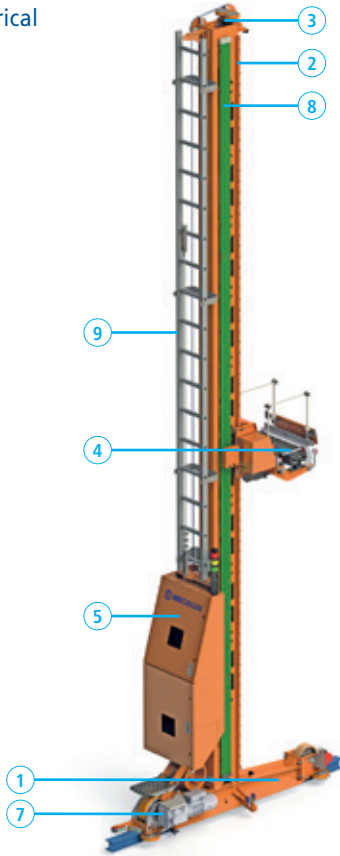

Light-duty ML50

It can handle a box of up to 50 kg at a height of 9 m.



Medium-duty ML100

It can reach up to 12 m high and transport two 50 kg boxes.

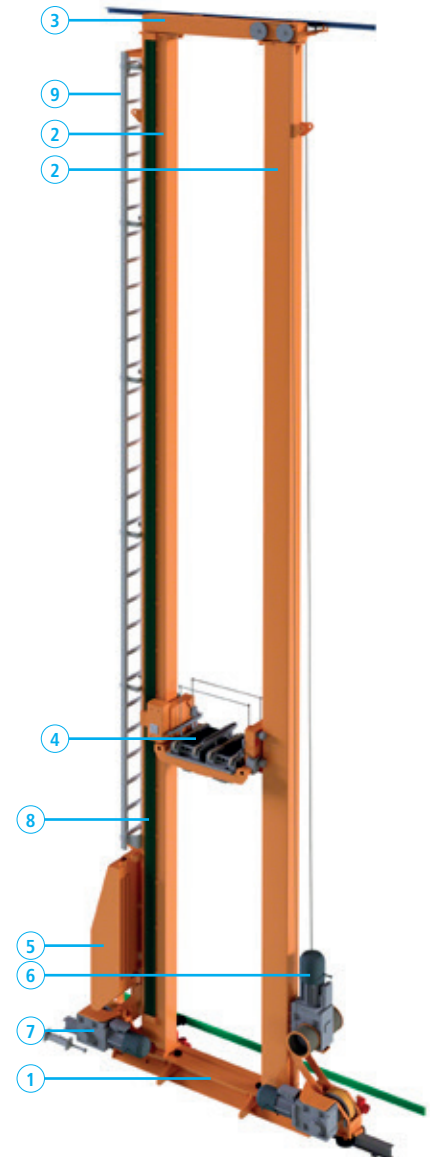

Heavy-duty MLB

It can exceed 20 m and transport four 50 kg boxes.

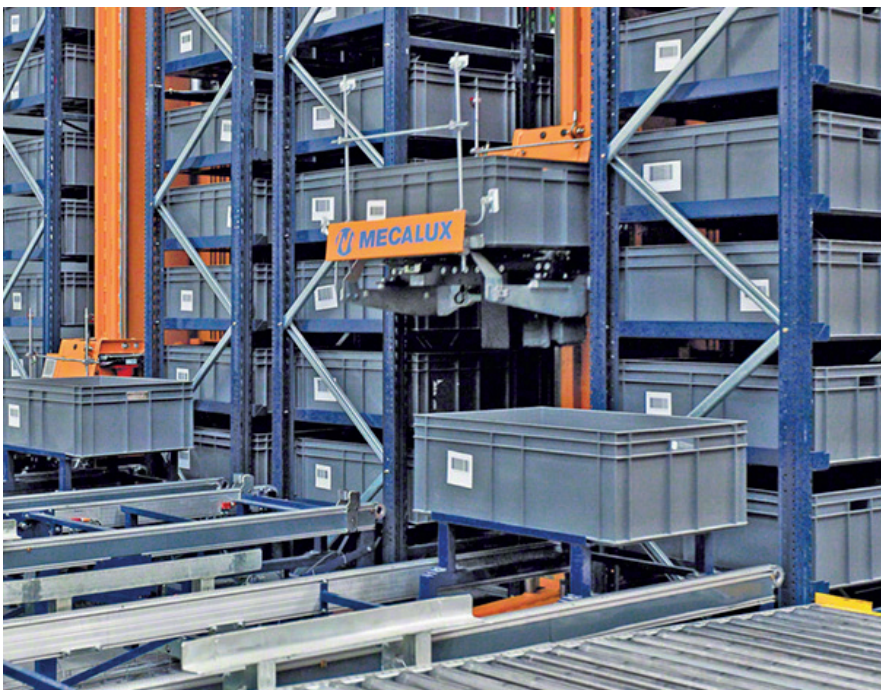

Conveyor systems for boxes

- ✓ Robust system designed to withstand **daily high-performance operations**.
- ✓ **Ergonomic and compact design** which facilitates interactions between the machine and the operator.
- ✓ **Low maintenance** and easy order processing.
- ✓ **Reduced operating cost**.



The automatic transport of light loads is commonly associated with high product turnover which can only be achieved with the perfect integration of all components that make up the installation.

A continuous transport system which can be scaled according to the growing needs of the customer.



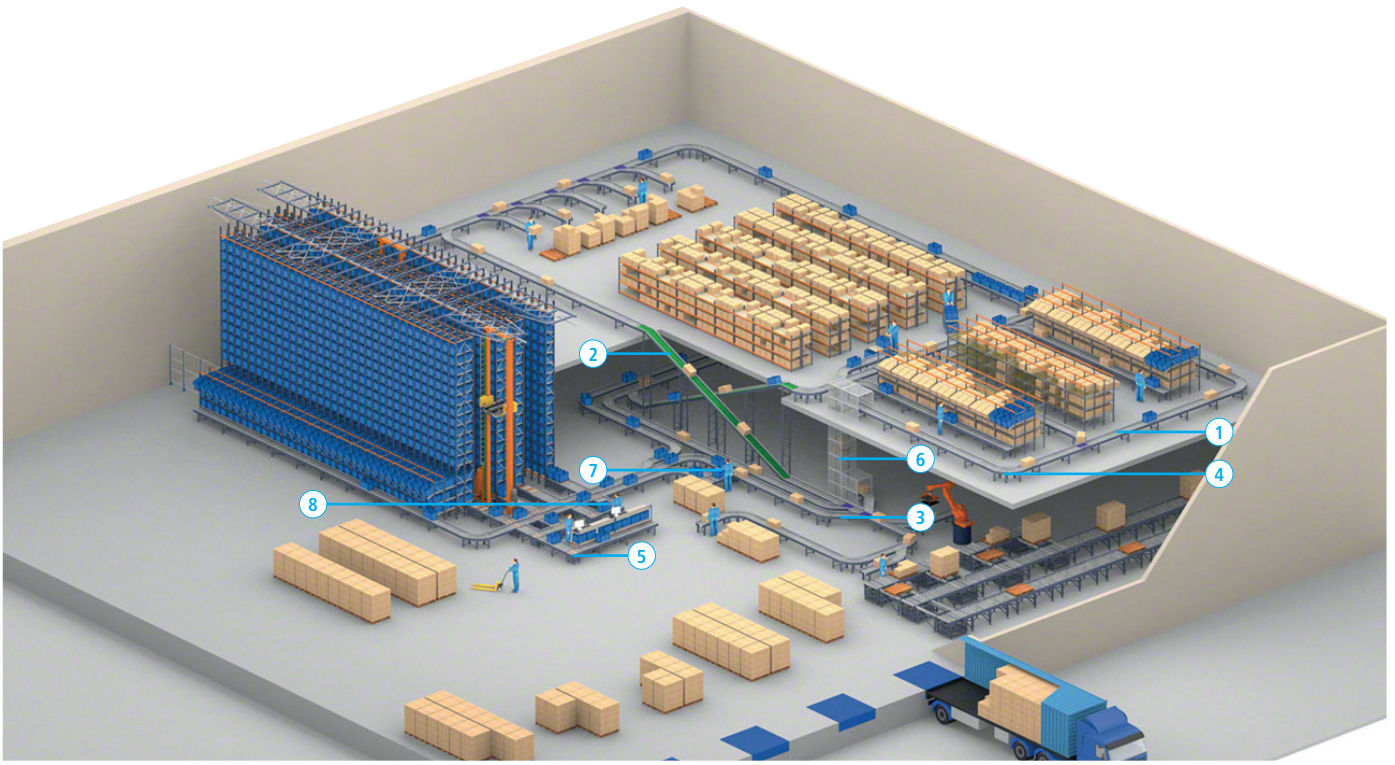

1. Roller conveyor
2. Belt conveyor
3. Oblique transfer
4. Curved roller conveyor (90° curve)
5. Mixed transfer roller & belt conveyor
6. Continuous lift
7. Assembly and verification station
8. Picking station



Straight conveyors
These allow the load units to be moved in a straight line and can also perform accumulating functions.



Continuous belt conveyor
Useful for moving boxes in a straight line when a uniform flow of load units is required, maintaining a constant distance or position between them.



Mixed transfer roller & belt conveyor
System for a 90° change in direction is combined with a fixed roller conveyor and a belt lift conveyor positioned at right angles.



Curved roller accumulation conveyor
Useful when the layout of your warehouse makes it impossible to employ straight lines, due to architectural or structural obstacles.



Cantilever racking for long loads

- ✓ Cantilever racking is ideal for the storage of **long loads** such as beams, profiles, pipes, timber, etc.
- ✓ **Simple, high strength** structure.



The system consists of columns with a vertical beam and one or two horizontal beams at the base to provide stability. A series of arms are attached, onto which the load is placed.

The height and weight of the product determine whether the cantilever racking needs to be light or heavy-duty. Both systems offer the possibility of locating storage levels on one side or both sides of the structure.



1. Upright
2. Arms
3. Feet
4. Cross bracing

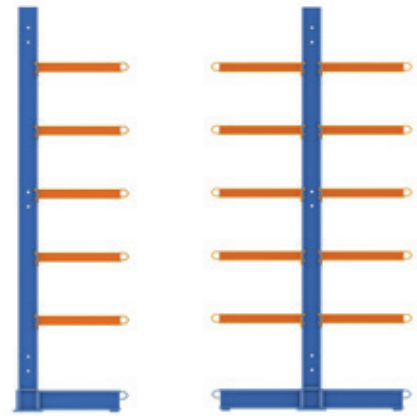
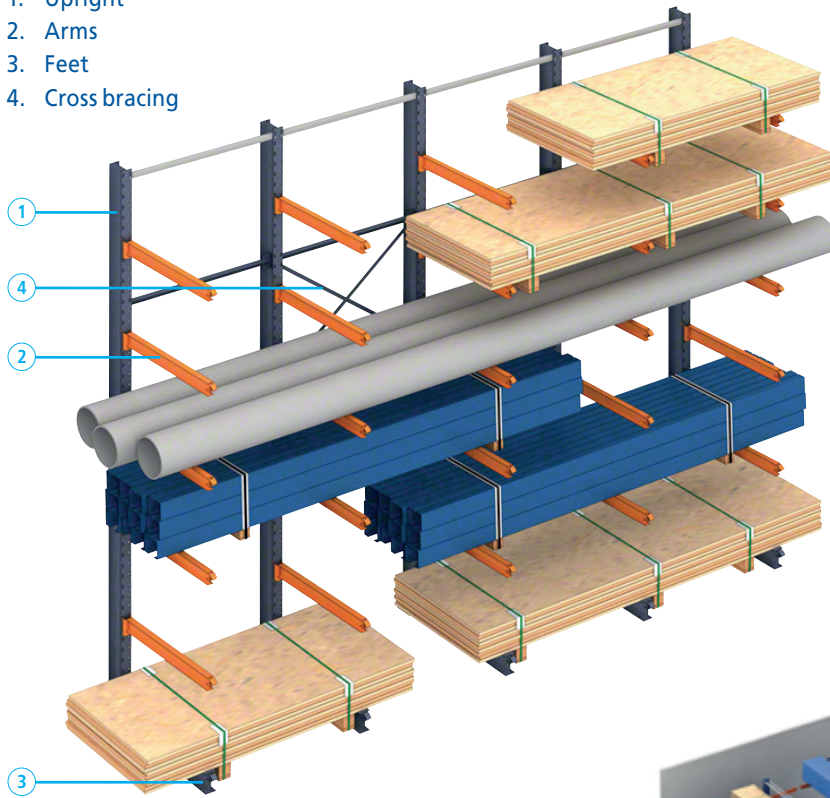

Single and double-sided versions

The warehouse is laid out with a combination of single-sided cantilever racks, normally placed against the walls with access from one side only, and double-sided cantilever racks that can be accessed from both sides.

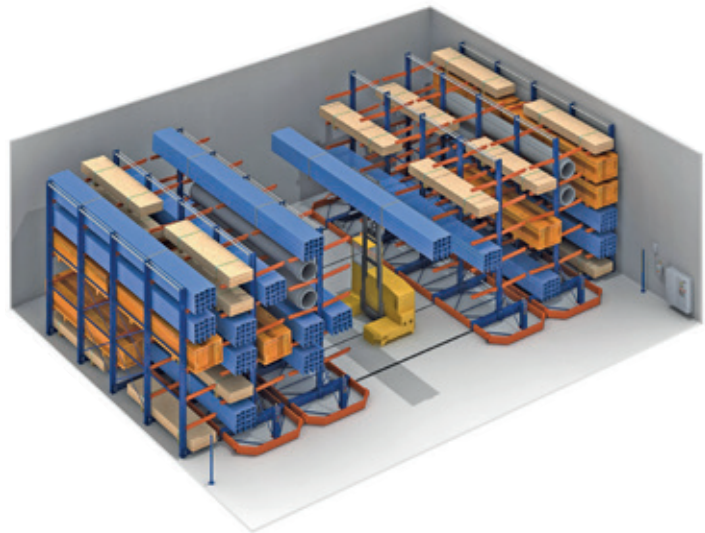

Cantilever racks on mobile bases

In order to increase the capacity of the space available, the cantilever system may be placed on mobile bases. The wheeled structure moves with integrated motors which run along rails set in the floor. These bases include a variety of control and safety systems to meet the needs of the client.

See more details about this product on page 8.

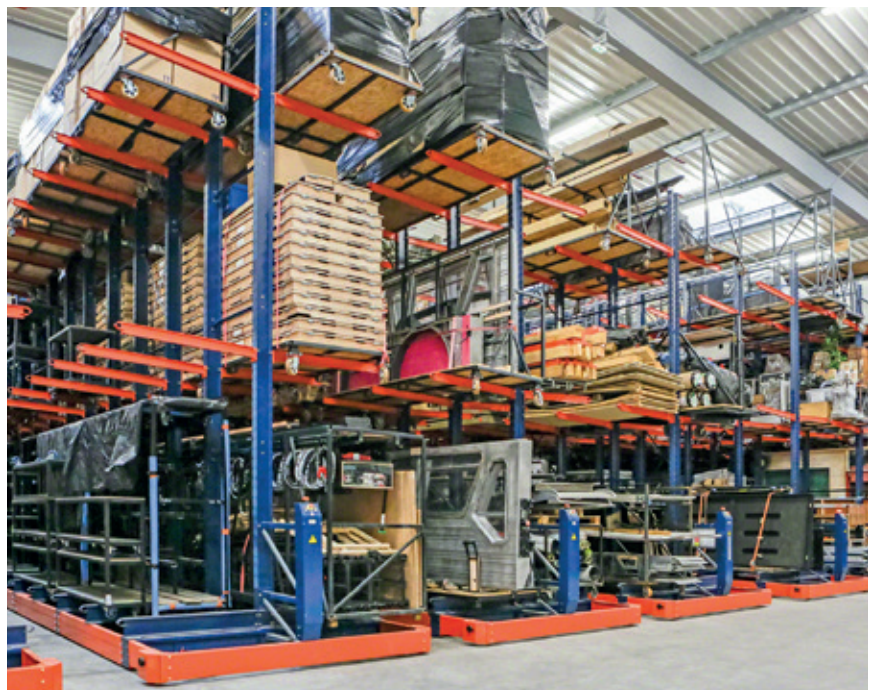

Mezzanine floors

- ✓ Industrial raised flooring to **multiply the original surface area**.
- ✓ **Quick and easy to assemble**.
- ✓ Can be **adapted to specific client requirements** thanks to the wide range of accessories, decking types, building systems, etc.



The installation of a mezzanine is the ideal solution to take full advantage of the surface area of any premises, making the most of the building's height.

Mecalux mezzanine floors can be fully dismantled, which means that all elements are recoverable, and their structure, dimensions and location can easily be modified.



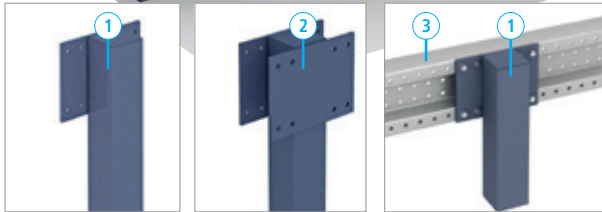
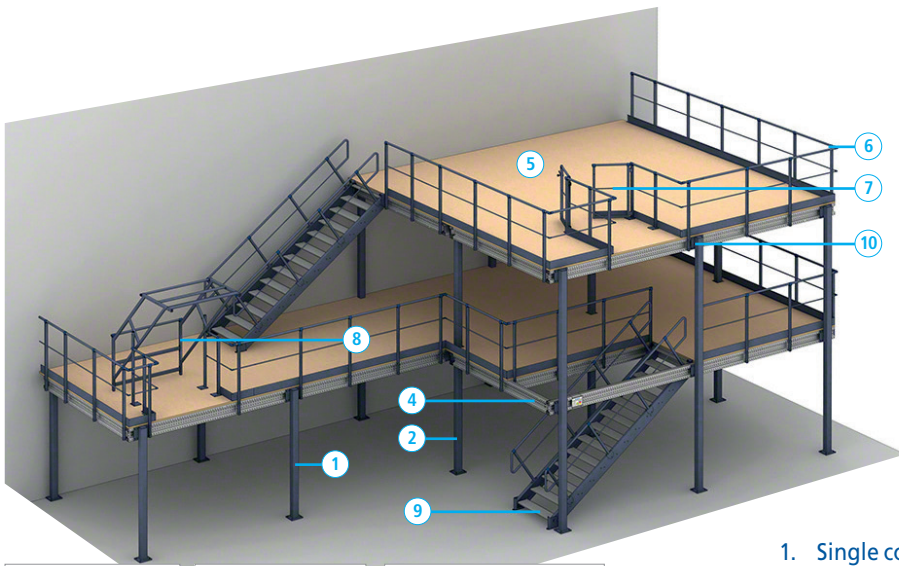

Single column

Double column

1. Single column
2. Double column
3. Main beam
4. Secondary beam
5. Floor
6. Safety railing
7. Swing gate
8. Up and over pallet gate
9. Staircase
10. Fastening plate



Safety rail



Swing gate



Up and over pallet gate

Wooden flooring



Chipboard panel flooring



Melamine chipboard flooring MA/ML



Wooden flooring with sheet metal

Metal floors

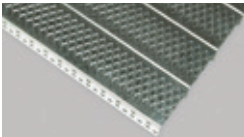

Corrugated metal

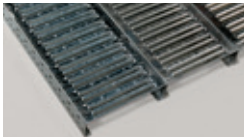

Slotted metal

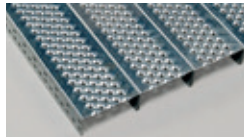

Perforated metal

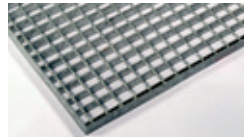

Metal grid

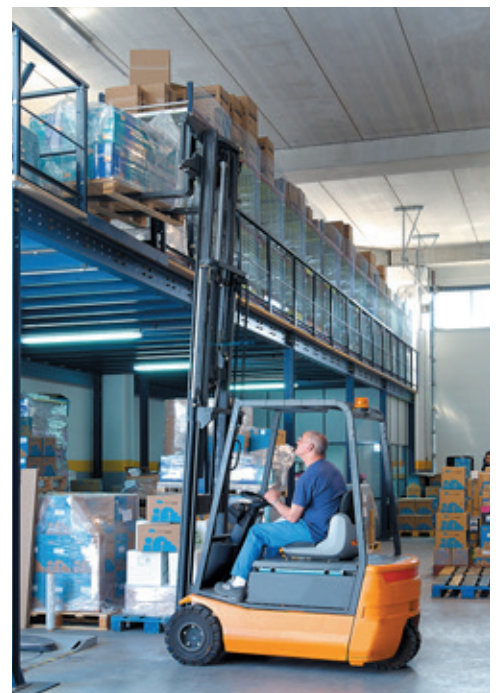

Mesh partitioning

- ✓ **Modular system**, adaptable to each area.
- ✓ **Easy and quick to assemble.**
- ✓ Simple to **extend and adjust.**
- ✓ Designed according to **European workplace safety standards.**



These create a protected space in work areas where there is automated equipment and robotics. They also keep the area free of possible materials shed by the action of machines.

Elements can be combined in any number of ways to partition off areas for diverse reasons: to separate manufacturing areas with moving machinery, or areas containing chemical products, to divide up different workspaces within a company, to create enclosures for control and maintenance areas, etc.

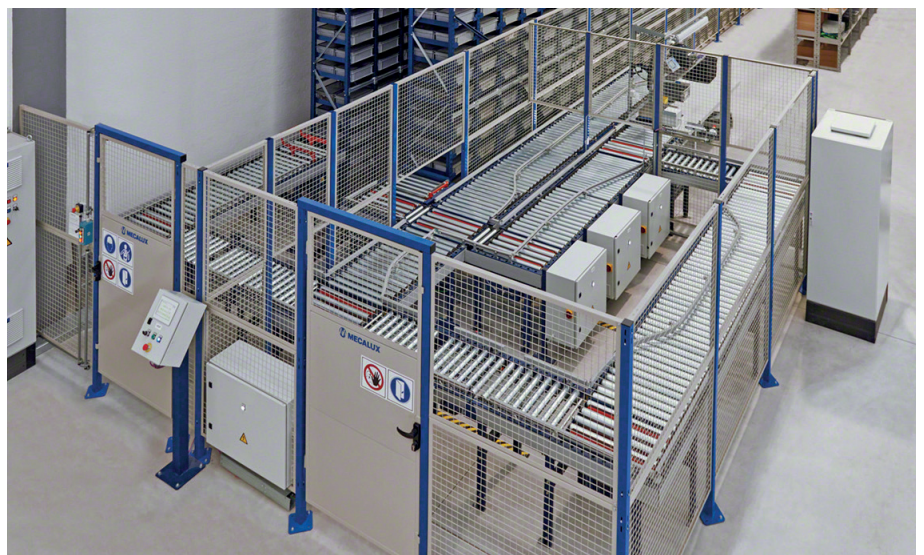

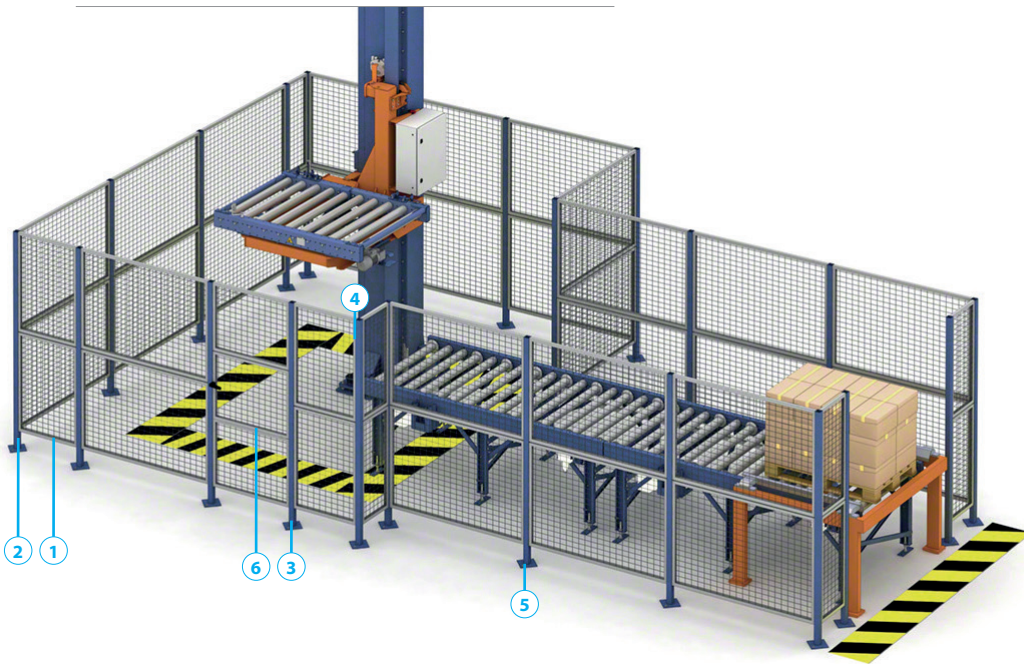

- 1. Metal panel
- 2. Pillar
- 3. Hinged pillar
- 4. Safety switch
- 5. Anchoring
- 6. Access gate

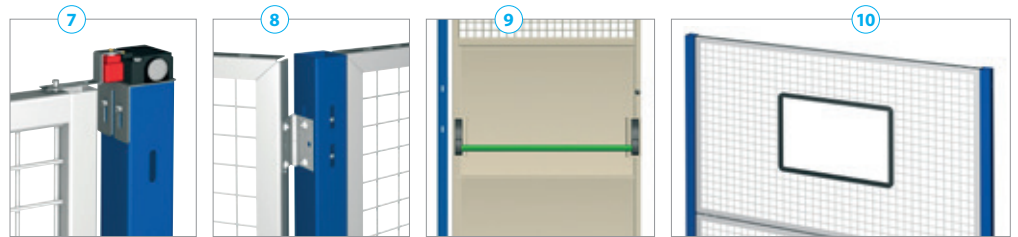

Accessories

- 7. Power-off switch
- 8. Hinged panel
- 9. Emergency exit
- 10. Plastic finish



Custom projects

- ✓ Consulting, analysing, developing, programming and setting up **custom projects**.
- ✓ **Vast experience** in adapting to a wide variety of specific requirements. Based on standard and customised elements.
- ✓ **Rapid**, effective and guaranteed solutions.



Mecalux designs, develops and installs customised storage system to suit the characteristics or special requirements of the warehouse in question.

Mecalux provides a solution for all storage requirements.



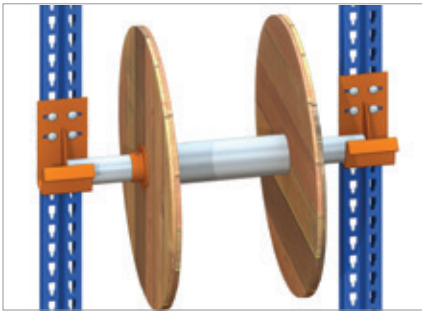
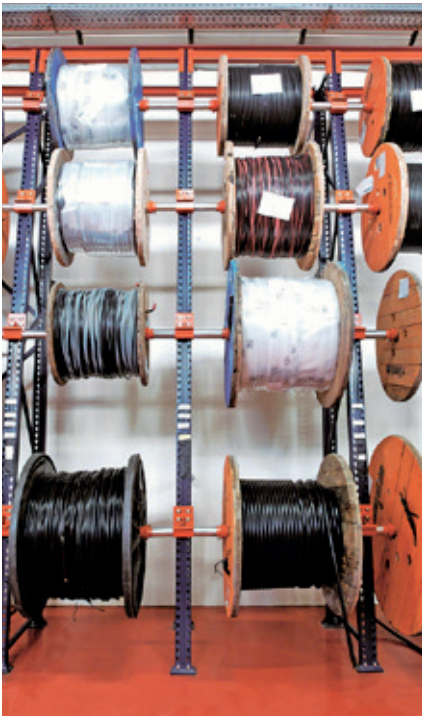

Racking for reels
Racking for reels is designed to provide a simple and safe solution for the storage of cylindrical items using a metal axle.



Easy WMS Warehouse Management System

- ✓ Receive real-time **stock** control.
- ✓ Lower logistics **costs**.
- ✓ Increase **storage** capacity.
- ✓ Reduce **handling** tasks.
- ✓ Eliminate **errors**.
- ✓ Get precise, high-speed **picking**.
- ✓ Adapt to new **e-commerce** needs.
- ✓ Manage **omnichannel** operations.
- ✓ Achieve a **fast ROI** (in 12-18 months).

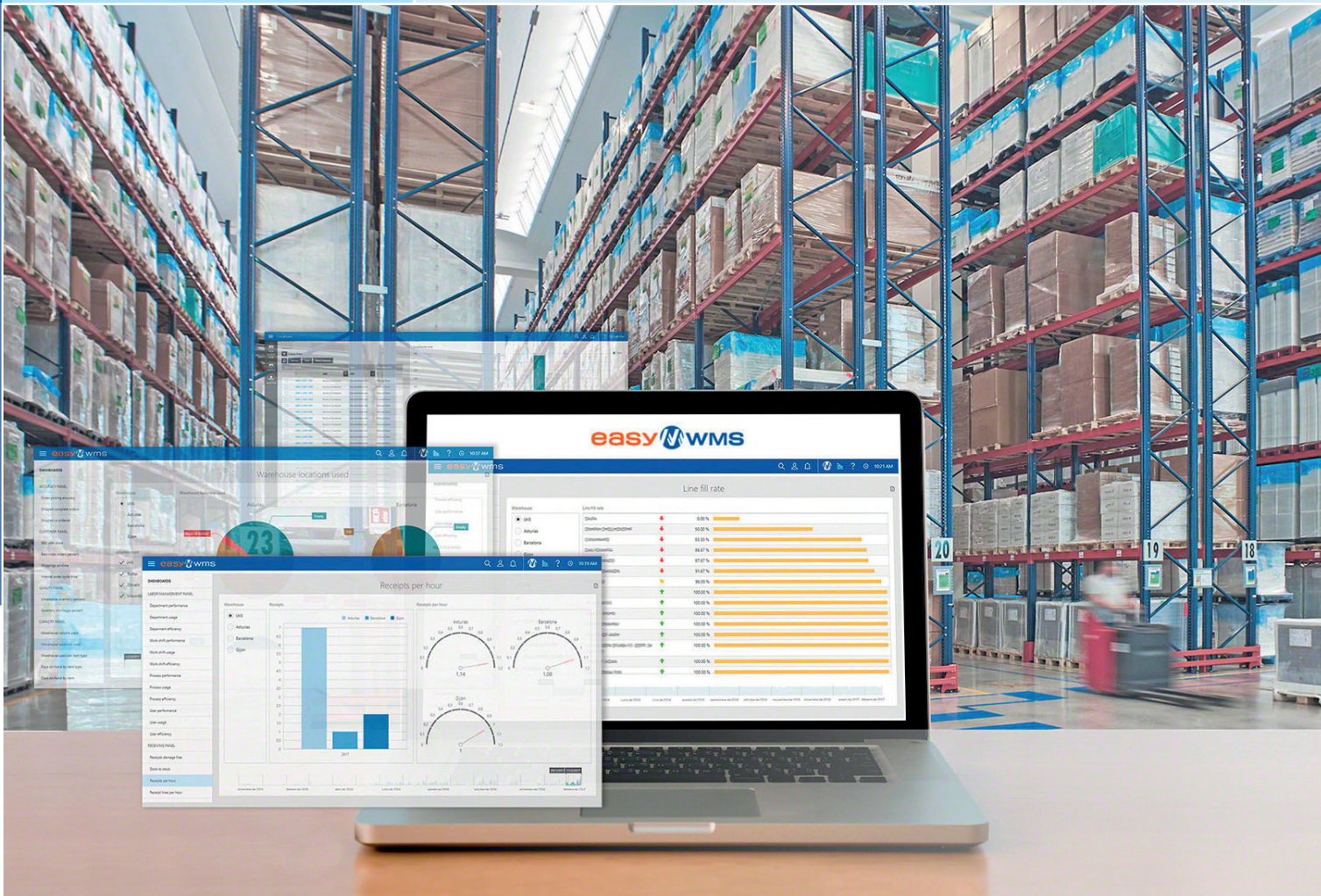

The Easy WMS platform optimises the physical and document management of product flows. This guarantees tracking and multiplies performance in all areas of the warehouse: reception, storage, order picking and dispatch. The various functional levels will suit any business sector.

It includes an extensive range of solutions, covering all the management needs of your logistics chain.



Mecalux works with leading suppliers that attest to the quality, reliability and technical level of the Easy WMS platform:



Microsoft Partner



Interconnected solutions for your supply chain



Multi Carrier Shipping Software
Automates product packaging, labelling and shipping. Coordinates direct communication between the warehouse and the various transport agencies.



Store Fulfilment
Synchronises inventory and workflows to ensure optimal stock management between the central warehouse and the network of brick-and-mortar shops.



Marketplace Integration
Synchronises the stock in the warehouse with the online catalogue in real time. Easy WMS automatically connects to the main digital sales platforms and marketplaces, e.g., Amazon, eBay and PrestaShop.



WMS for Manufacturing
Facilitates traceability in manufacturing processes. Guarantees the continuous supply of raw materials to the production lines.



WMS for 3PL
Manages billing between a 3PL and its customers. A dedicated access platform provides information on stock condition and how to place orders or request customised shipments.



Yard Management System (YMS)
Supervises the movement of vehicles in the yard at the warehouse or distribution centre. Optimises loading dock operations to improve vehicle flow and avoid bottlenecks with inbound and outbound goods.



Labour Management System (LMS)
Maximises operational productivity. It objectively measures operator throughput, detecting opportunities for improvement for the company.



Slotting for WMS
Optimises slotting management in the warehouse. It determines the optimal slotting for each SKU based on a set of predetermined rules and criteria (historic, current and future demand).



Value-Added Services (VAS)
Facilitates product personalisation to drive customer satisfaction. The software sends operators step-by-step instructions on how to customise items and eliminate errors.

Easy WMS in the cloud

- » **Lower initial investment** since in-house servers are not needed.
- » Faster, simpler **implementation**.
- » Easier, more affordable **technical support and maintenance**. Total security with Microsoft Azure.
- » Software **version up-to-date** at all times.
- » **Maximum availability** to guarantee business continuity.
- » **Fees adapted** to the needs of each business.

Gartner

**MECALUX IN THE
2024 GARTNER®
MAGIC QUADRANT™
FOR WMS**

GARTNER is a registered trademark and service mark of Gartner, Inc. and/or its affiliates in the U.S. and internationally, and MAGIC QUADRANT is a registered trademark of Gartner, Inc. and/or its affiliates and are used herein with permission. All rights reserved. Gartner does not endorse any vendor, product or service depicted in its research publications, and does not advise technology users to select only those vendors with the highest ratings or other designation. Gartner research publications consist of the opinions of Gartner's research organisation and should not be construed as statements of fact. Gartner disclaims all warranties, expressed or implied, with respect to this research, including any warranties of merchantability or fitness for a particular purpose.

Technical inspections of racks

- ✓ Improving the **safety** of your warehouse.
- ✓ **Reducing risks** caused by forklifts or other material handling equipment.



In order to keep your warehouse safe, it is essential to carry out regular inspections to verify that the racks are in good condition.

The use of forklifts and other handling equipment can cause damage to racks and lead to accidents in the warehouse.

Standard UNE-EN 15635 requires an annual inspection of your installation by external, qualified personnel.

Mecalux has offered its customers technical inspection services for more than 25 years, to ensure that their warehouses are safer and more efficient.



INSPECTION PLAN

Our technical specialists will perform a thorough technical inspection of the racks to confirm the following:

- General condition of **racks**.
- Good condition and suitability of **pallets**.
- Installation **storage levels**, ensuring they match those indicated in the plan.
- Suitability of **forklifts** and **unit loads** for racking.
- Existence and visibility of **safe load warning notices**.
- **Manoeuvres** are performed correctly by operators.
- **Aisles** are kept clean and in good order.
- Existence of and need for **upright protection**.
- Cracks, subsidence or possible defects in the **floor**.
- **Tolerances and deformations** of the racks, to ensure they do not exceed set limits.
- Identification of **elements in poor condition** using stickers.
- Notification of **possible risks** in the installation, and potentially, the need to unload bays and levels immediately.



Risk classification

Inspections performed by Mecalux will cover the general condition of the racks, and possible damage will be identified using stickers.



Green level

Only requires monitoring

- ✓ No reduction in capacity required.
- ✓ The components are safe and serviceable.
- ✓ Re-examination and assessment required in future inspections.



Amber level

Action required as soon as possible

- ✓ Proceed with replacing the damaged components.



Red level

Immediate action

- ✓ Unload rack immediately, block off access and refrain from further use.

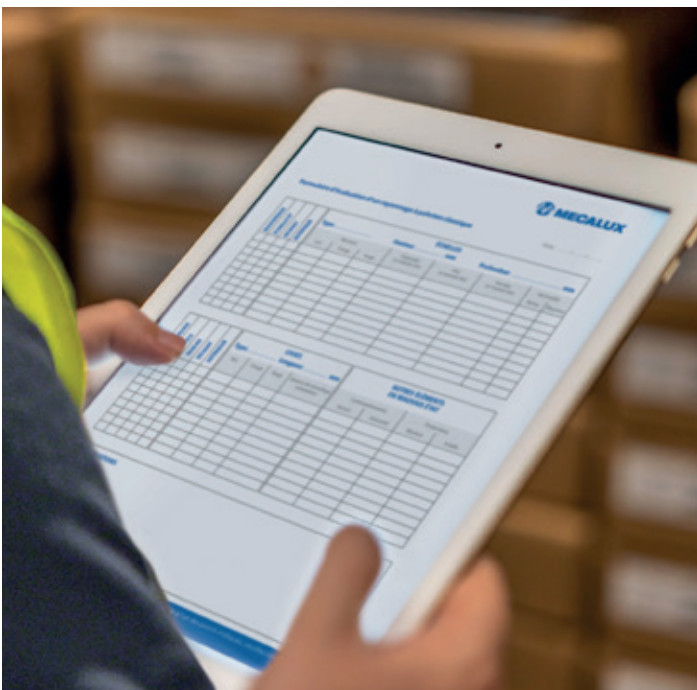

Production centres



Plant in Cornellà
(Barcelona), Spain



Plant in Gijón,
Spain



Plant in Palencia,
Spain



Plant in Gliwice,
Poland

International presence



Plant in Chicago,
USA



Plant in Pontiac,
USA



Plant in Sumter,
USA



Plant in Matamoros,
Mexico



Plant in Tijuana,
Mexico



Plant in São Paulo,
Brazil



Plant in Buenos Aires,
Argentina

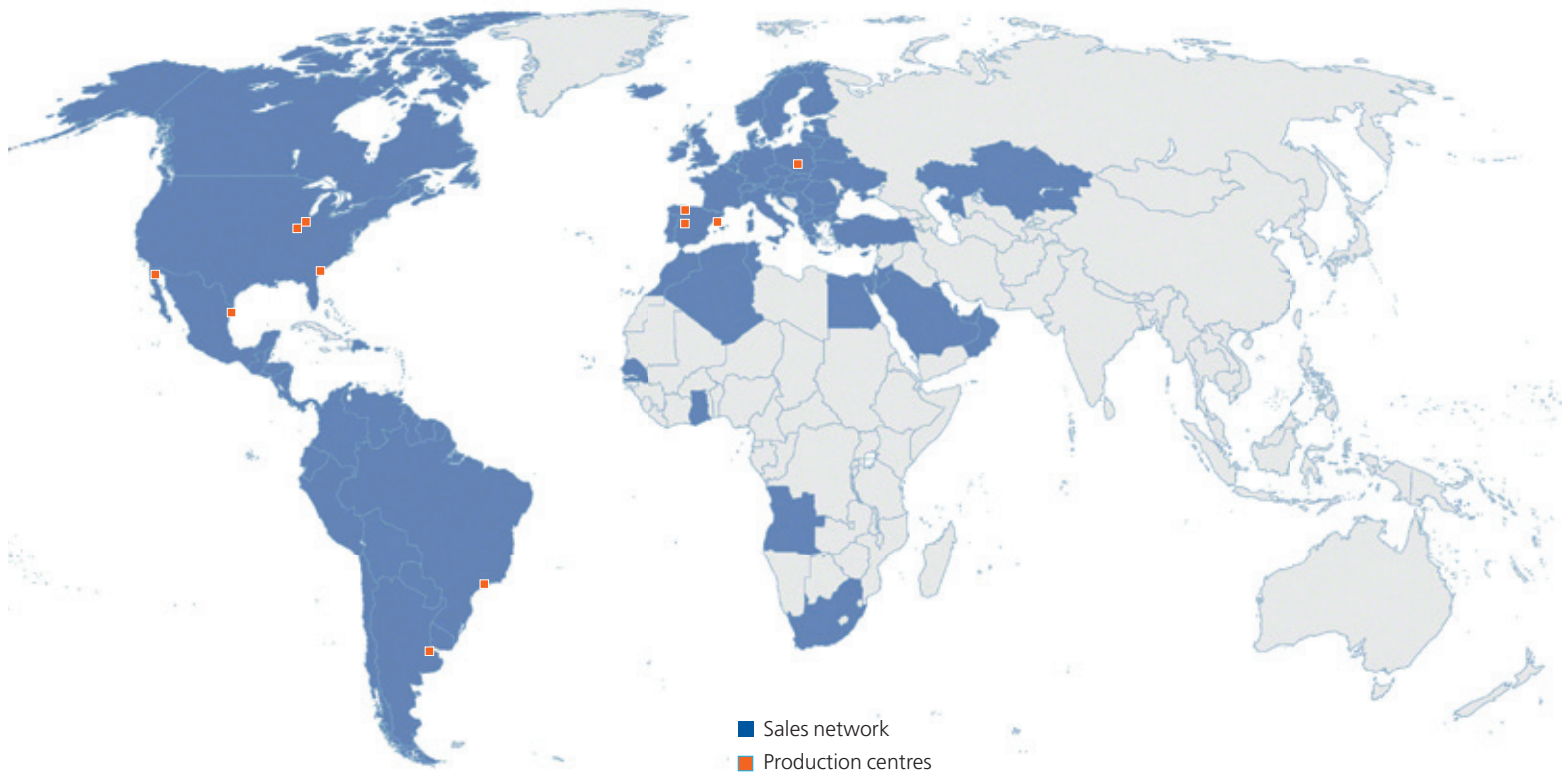

Visit our web for more information mecalux.sk



e-mail: obchod@mecalux.com - mecalux.sk

MECALUX Slovensko, s.r.o.

tel: +421 220 545 117

Boženy Němcovej 8
811 04 Bratislava

Mecalux má zastúpenie vo viac ako 70 krajinách celého sveta

Výrobné / obchodné pobočky: Argentína - Belgicko - Brazília - Česko - Chile - Chorvátsko - Francúzsko - Taliansko
Kanada - Kolumbia - Mexiko - Nemecko - Holandsko - Poľsko - Portugalsko - Rumunsko - Slovensko - Slovinsko - Španielsko
Spojené kráľovstvo - Turecko - Uruguay - USA

