



Metal Point Boltless Shelving



Metal Point Boltless Shelving

Storage-related processes have become a strategic element in supply chain management, and therefore in the creation of value in business.

Moreover, a detailed study of the needs and operations performed in a warehouse is essential in order to optimise space and thus reduce costs and time taken to prepare orders.

Installing Metal Point boltless shelving makes this reduction in cost and time possible. In addition to being a highly versatile and adaptable system, it is easy to keep goods well ordered thanks to the wide range of models and accessories available.

The Mecalux Group has more than 50 years' experience in the installation of storage systems and equipment across all sectors of the market, using the most advanced technology in the industry.



Contents

Features	4
Advantages	5
Heavy-Duty Metal Point Shelving	6
Basic components	7
Applications	12
Medium-Duty Metal Point Shelving	14
Basic components	15
Applications	17
Metal Point Shelving with Raised Walkways	18
Basic components	19

Metal Point boltless shelving can be adapted for endless uses and applications in your warehouse, office, or home... For any kind of load that you need to store, and keep in perfect order, there is a Metal Point shelf for you!



Features of Metal Point Shelving

A boltless storage system that can be easily adapted to any setting, from the warehouse to your home.

At the forefront of structural design, calculation and testing, in accordance with the latest FEM standards, Metal Point shelving is the perfect choice in both small and large installations.

Thanks to the quality of the steel, the advanced manufacturing systems and



its simple yet exclusive assembly, Metal Point shelving is far superior to other picking systems on the market.



Advantages of Metal Point Boltless Shelving

- **Easy to assemble.** All of the pieces fit perfectly together, quickly and easily, using just a plastic or rubber mallet, without any need for bolts.
- **Fully modular.** Extra modules or additional levels with raised walkways can be added, making installation possible in any location or for any business.
- **Versatile.** There are Metal Point shelves for all loads and weights.
- **Great durability.** A coat of polyester-epoxy paint at least 50 to 75 microns thick guarantees a long-lasting, perfect finish.





Heavy-Duty Metal Point Shelving

Ideal for storing heavy items or products in your warehouse, workshop, store, business, office or any other industrial premises. Metal Point is available in a variety of sizes and can be adapted to suit any need.



The simple structure makes it possible to install several load levels, up to a maximum height of 3,762 mm, and allows for easy extension of the warehouse's length simply by adding as many modules as necessary.

Chipboard panels are the most commonly used, as these can hold loads of up to 960 kg per level, when loads are evenly distributed.





Standard colours

Upright

-  RAL 5019
-  RAL 7032
-  Galvanised

Beam

-  RAL 2004
-  RAL 7032
-  Galvanised

Maximum load

Height (H): 1,981 / 2,438 / 3,048 / 3,657 mm

For depths (B) of 316 / 468 / 621 mm:

Length (L)	1,231	1,536	1,841	2,146	2,450
NLE	590	440	190	-	-
NLE+NSTS	770	640	420	-	-
NCLE	960	706	536	400	200
NCLE+NSTS	1,100	800	610	577	545

For depths (B) of 773 / 926 / 1.231 mm:

Length (L)	1,231	1,536	1,841	2,146	2,450
NLE	467	344	200	-	-
NLE+NSTS	800	640	420	-	-
NCLE	760	560	420	323	200
NCLE+NSTS	920	860	740	620	500

Evenly distributed load in kg/level. Dimensions in mm.

Basic components

1. Bracket
2. NLE beam
3. NCLE beam
4. Cross-tie
5. Bracing
6. Chipboard panel
7. Galvanised panel
8. Slotted metal panel
9. Joining profile
10. Ending profile
11. Bracket union
12. Plastic footplate
13. Single metal footplate
14. Double metal footplate
15. Shim plate

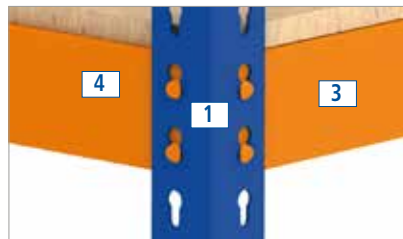
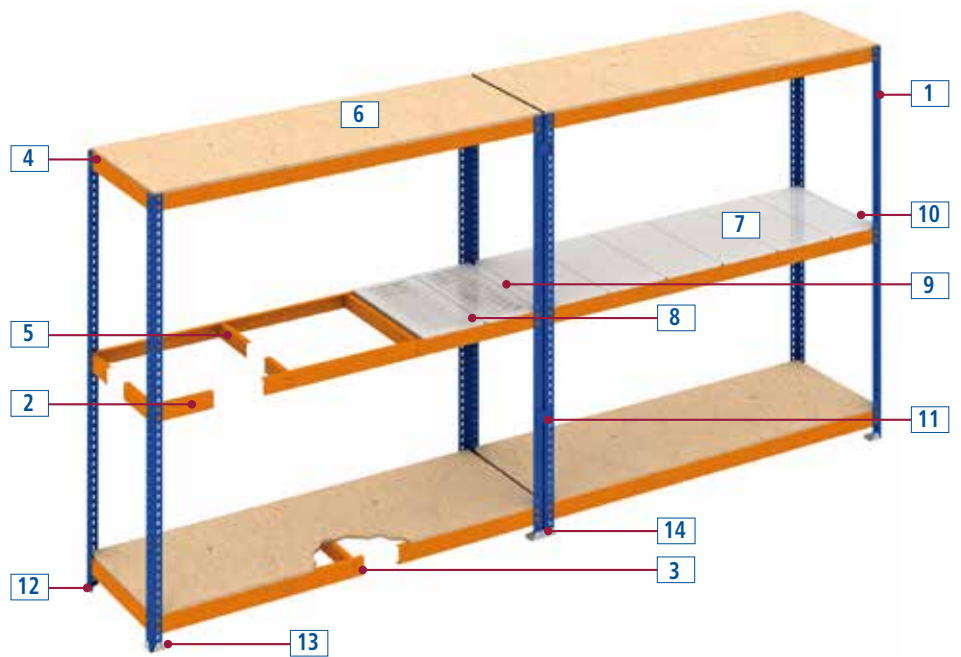

Joint between bracket (1), cross-tie (4) and beam (3)

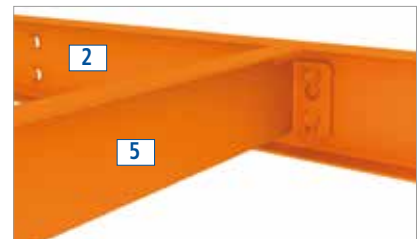

Joint between beam (2) and bracing (5)

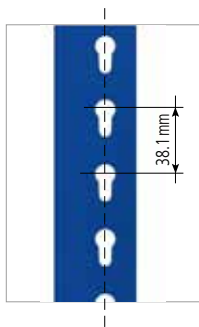

Bracket

A slotted L-shaped piece into which the beams are fitted.

Its dimensions are 48 x 48 mm with a steel thickness of 1.5 or 2 mm. The height varies depending on requirements.

Plastic footplate

Fitted to the base of the uprights, this ensures the structure is well supported, and avoids direct contact between the uprights and the floor.



Metal footplates

Placed under the bracket as a supporting piece, distributing the load evenly on the floor, these pieces are used instead of plastic covers for heavy loads.

There are two models: single (13) and double (14). The single model has only one bracket, while the double connects the brackets of two different modules.

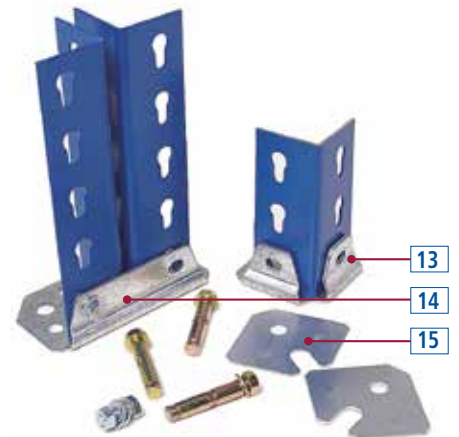

Shim plates (15)

These plates are placed under the metal footplates when the shelving needs to be adjusted to sit flush on the floor.





N LE and N CLE beams

These profiles are fitted to the uprights and used to support the panels. One or the other is used depending on whether the panels are made of wood or metal.

Beam length	
N LE	N CLE
1,231	1,536
1,536	1,841
1,841	2,146
	2,450

Length in mm.

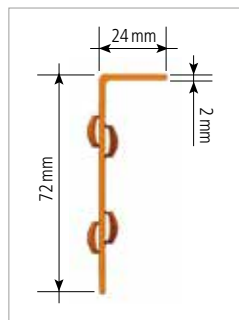

N LE Beam

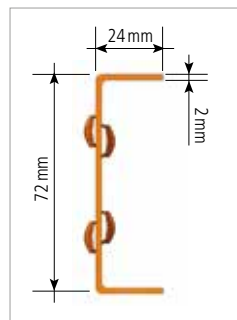

N CLE Beam

Cross-tie

This profile is used to join the brackets, to ensure structural rigidity. It is also used for support.

The most common lengths are: 279, 468, 621, 773, 926 and 1,231 mm.

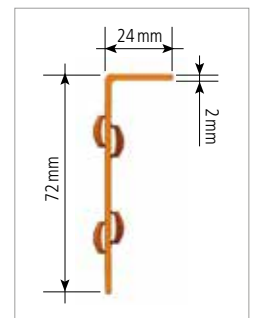



Bracing

This piece is placed across the beams to reinforce the panels, preventing them from becoming bowed. Chipboard panels are generally braced in the middle of the beam.

The most common lengths are: 468, 621, 773, 916 and 1,231 mm.

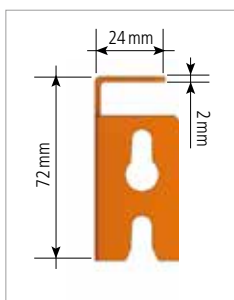

Spacer

A piece of galvanised metal used to fix the shelving to the wall. It is secured in position by a locking pin, which holds the spacer and bracket together in the event of sudden movements.



Bracket union

This piece is used to join two modules together lengthwise, ensuring correct alignment and spacing while guaranteeing the structural rigidity in this plane.



Locking pin

Spacer

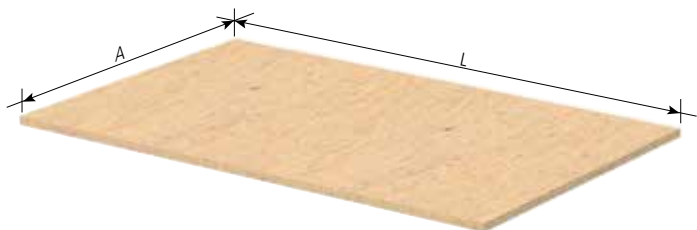

Chipboard or melamine panels

16 mm thick panels that are placed on N LE beams.

When two chipboard panels are used, two connecting clips are fitted per shelf, one on each beam, to prevent them from moving.

Dimensions of the panels	
Width (A)	Length (L)
316	1,231/1,536/1,841/2,146/2,450
468	1,231/1,536/1,841/2,146/2,450
621	1,231/1,536/1,841/2,146/2,450
773	1,231/1,536/1,841/2,146/2,450
926	1,231/1,536/1,841/2,146/2,450
1,231	1,231/1,536/1,841/2,146/2,450

Dimensions in mm.

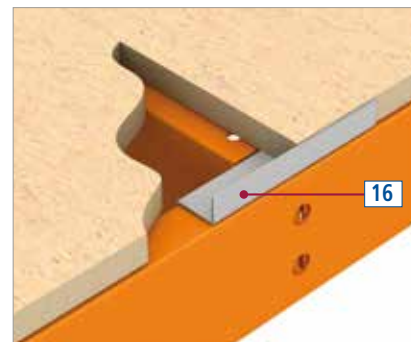

Connecting clip (16)



Metal Panels

These panels, made from a single piece of galvanised sheet metal with folded edges, are able to support large loads.

Their width can vary, so a different number of panels may be placed on each level. The number depends on the length of each panel and of the module as a whole.

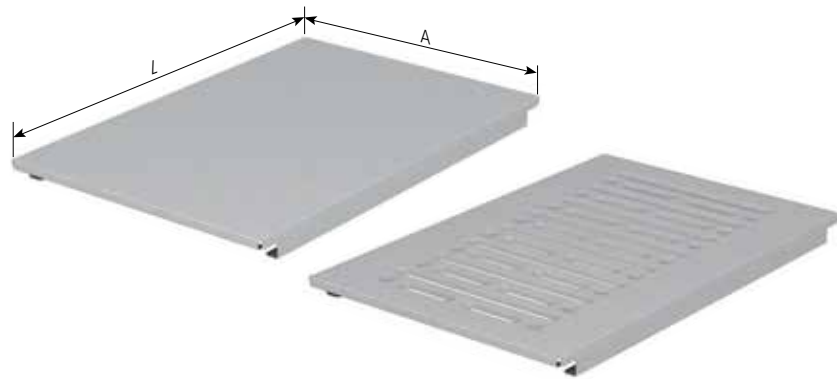

Dimensions of the panels

Width (A)	Length (L)
260	461/613/765/918/1,222
305	461/613/765/918/1,222

Dimensions in mm.

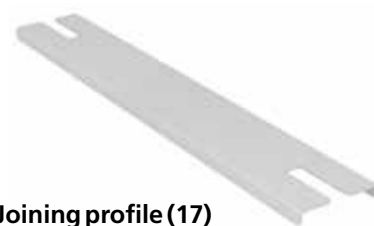

Joining profile (17)

Used to fill the empty space between two metal panels on different modules.

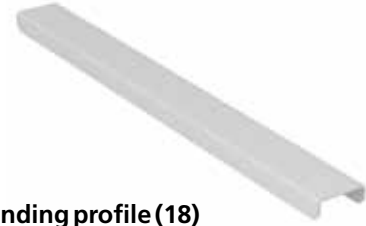

Ending profile (18)

Fitted at the end of a shelf to fill any remaining empty space.

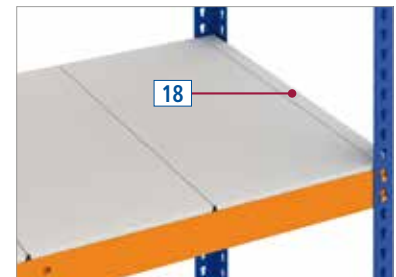
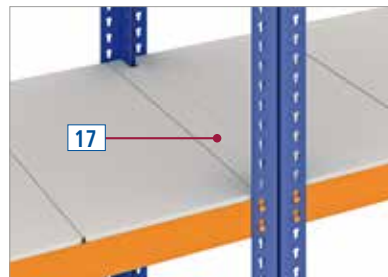

Applications

The versatility of this system offers a wide range of solutions, such as shelves, benches, tables, cupboards and more.

Workbenches and tables

Mecalux offers many combinations of the Metal Point Plus system that can be adapted to suit any need, available in a wide variety of sizes and capable of carrying loads of up to 450 kg.

With Metal Point Plus workbenches, you will be able to organise all of your tools with ease.



Workbench with shelves and footrest



Workbench with footrest



Workbench with tool cabinet



Packaging bench



Work table with footrest



Shelf unit with drawers



Work table



Work table with tool drawer



Auxiliary table with wheels



Tool cabinet



Bench



Tyre racks

The sturdy construction of these racks makes them ideal for storing car tyres.



Single tyre rack



Double tyre rack

Shelves for upright storage

Mecalux also offers a Metal Point Plus shelf type for storing paper, cardboard, hanging garments, etc.



Upright storage of items



Shelves for hanging garments or other items



Medium-Duty Metal Point Shelving



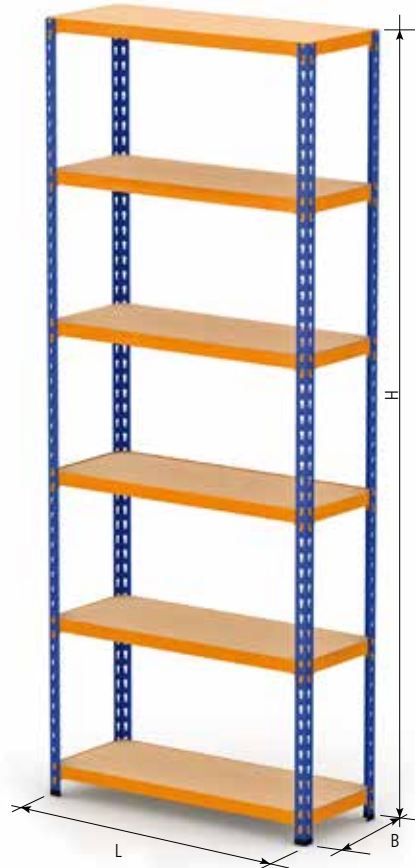

Medium-Duty Metal Point Shelving

An attractive design means that these shelves can be adapted for any setting where items of medium weight need to be stored.



Standard colours

Upright

-  RAL 5019
-  RAL 8017
-  Galvanised

Beam

-  RAL 8024
-  RAL 2004
-  RAL 7032
-  Galvanised

Maximum load

Height (H): 1,981 / 2,438 / 3,048

For depths (B) of 316 / 377 / 468 / 621 mm:

Width (L)	621	743	926	1,027	1,231
Load*	500	375	340	275	200

* Evenly distributed load in kg/level. Dimensions in mm.

Basic components

1. Bracket
2. Beam
3. Cross-tie
4. Chipboard or melamine panel
5. MR2 galvanised panel
6. Plastic footplate
7. Retainer
8. Divider

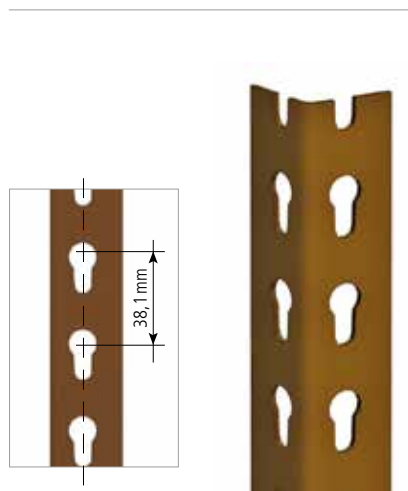
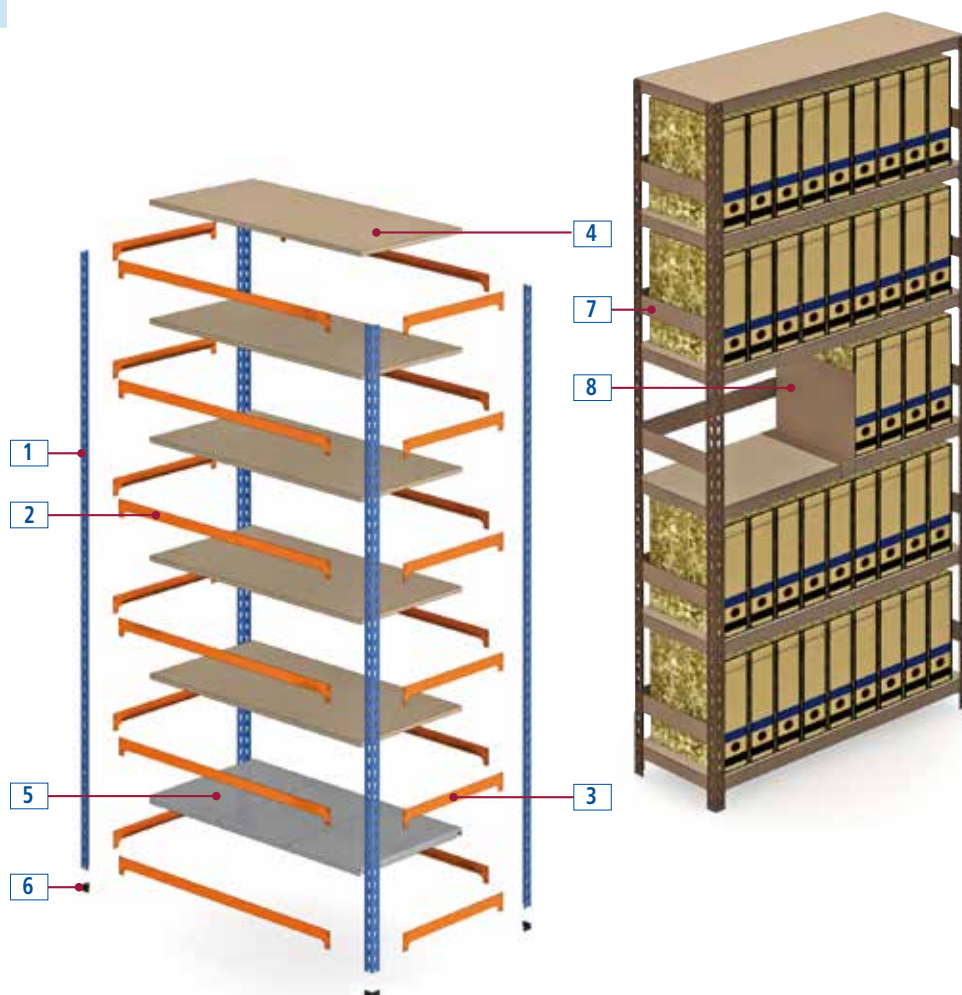

Bracket

A slotted L-shaped piece into which the beams are fitted. It differs from the heavy-duty brackets in terms of its size: 31.7 x 31.7 mm with a steel thickness of 1.8 mm.

These uprights can reach a maximum height of 3,048 mm.



Securing pin

Spacer

Spacer

A metal piece used to fix the shelf to the wall. Normally a securing pin is used to hold the parts in place, and prevent them separating if they experience any movement.



Plastic Footplate

Placed on the bottom of the bracket to cushion its contact with the floor.



TE-2 Union

This is the metal piece that joins the uprights of two different modules, aligning them and ensuring the rigidity of the structure.



Beam

This is the profile which is fitted to the bracket, used to bear the horizontal load. Its function is not only to join two uprights, but also to create a level and support the panel on which the load rests.

The length of this beam is: 1,536 mm.

Cross-tie

A short profile used to join the two brackets which hold the load-bearing beams, to ensure structural rigidity.

The most common lengths are: 316, 377, 468, 621, 743, 926, 1,027, and 1,231 mm.

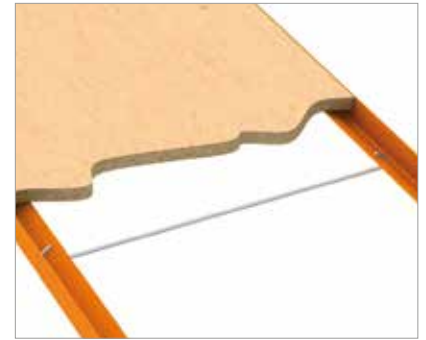

Cross bracing

When it is necessary to increase the load capacity on a level, cross bracing is added to the beams. These pieces are fixed to both beams approximately halfway along their length.



Wooden panel

Available in different sizes to suit any need.

It can be made from bare chipboard or melamine.



Metal panels

These galvanised panels fit exactly onto the beams, slotting over the vertical edges.

A level is made up of several panels of varying widths depending on the overall width of the level and the weight of the product to be stored.



Retainers and dividers

These accessories are used to prevent the goods stored on the shelves from falling.



Divider

Load capacities

	Width		Length			
	621	743	926	1,027	1,231	
316	500	375	340	275	200	
377	500	375	340	275	200	
468	500	375	340	275	200	
621	500	375	340	275	200	
743		375	340	275	200	
1,231			340	275	200	

Evenly distributed load in kg/level.
Dimensions in mm.

Load capacities

	Length		
	621	926	1,231
316	180	135	101
377	200	143	104
468	214	178	114
621	172	188	124

Evenly distributed load in kg/level.
Dimensions in mm.



Applications

Medium-duty Metal Point shelving has numerous applications thanks to the wide range of accessories available. This makes it extremely versatile, and it can be used in virtually any setting.

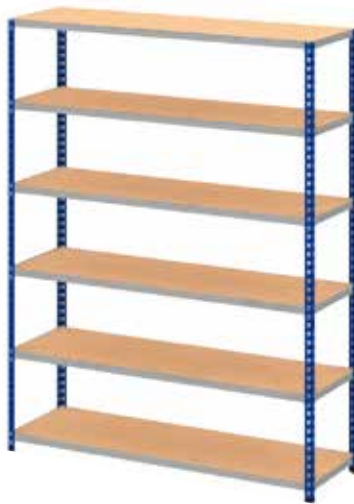

Fabric racks

Items of clothing or other products can be hung from this shelving unit simply by adding levels with hanging rails.

The combinations are endless, as the shelves are completely adjustable.

Wine storage racks

Metal Point light-duty shelving is also ideal for storing bottles of wine.





Metal Point Shelving with Raised Walkways

Metal Point shelving allows for raised walkways to be installed in order to optimise vertical space, doubling the storage area.

In order to access the different levels, stairs can be installed in specific locations, selected based on the criteria of accessibility and safety. Thanks to this feature, endless combinations can be created to suit the specific needs of each warehouse.

Furthermore, this system's adaptability means that existing warehouses can be extended to make them longer or wider.

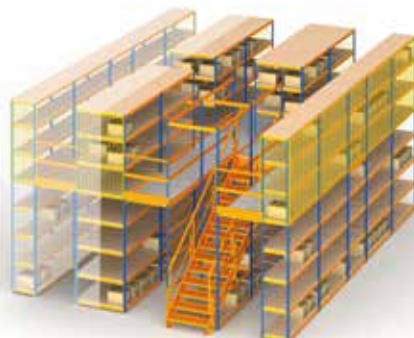

Extended width



Extended length

Standard colours

Upright and beam



RAL 5019



RAL 2004

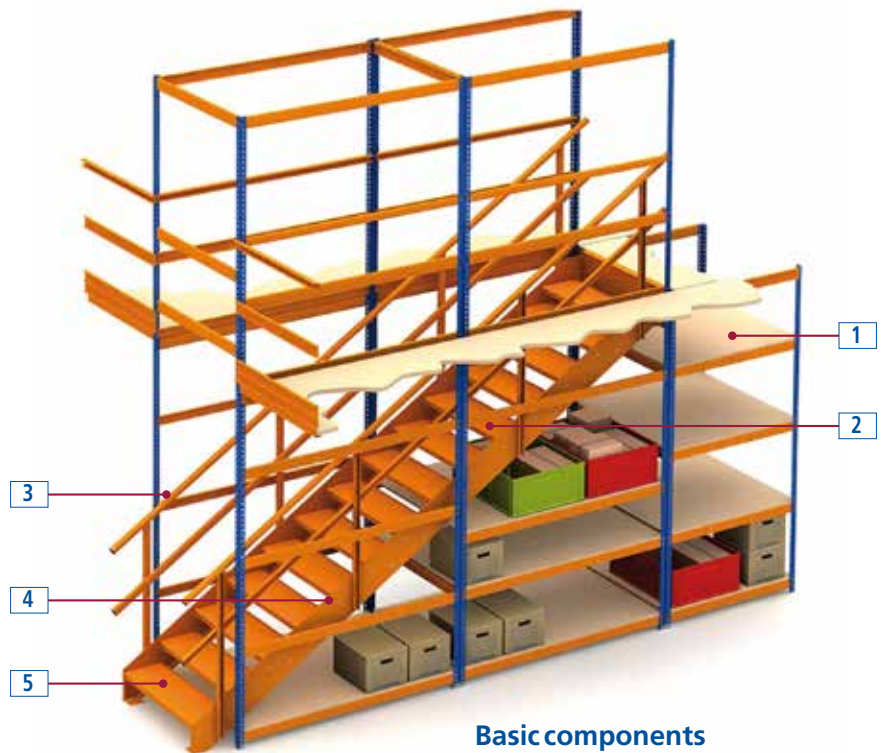

Basic components

1. Floor
2. Stairs
3. Handrail
4. Support beam
5. Step

In this type of structure Metal Point Plus is used, since it is the option with the greatest load-bearing capacity.



Support beam

This is the profile that joins the stairs to the Metal Point shelving structure.



Handrail

This is a rectangular profile with a plastic cap on the end.

Floor

There are different types of floor to meet different needs, depending on the load, type of work, handling equipment used, etc.

These floors can be made of chipboard, single-sided melamine, or metal panels when greater load capacity is required.



Metal step

Made of sheet metal and painted orange, Mecalux offers steps in two different widths: 900 and 1,000 mm.



Landing

When necessary, landings can be installed.



e-mail: bratislava@mecalux.com - mecalux.sk

MECALUX SLOVENSKO, S.R.O.

BRATISLAVA

tel: 00421 220 545 117

Boženy Němcovej 8 - 811 04 Bratislava

fax: 00421 220 545 118

Mecalux má zastoupení ve více než 70 zemích celého světa

Zastoupení: Argentina - Belgie - Brazílie - Česko - Chile - Francie - Itálie - Kanada - Kolumbia - Mexiko - Německo
Nizozemí - Peru - Polsko - Portugalsko - Slovensko - Španělsko - Spojené Království - Turecko - Uruguay - USA

